

Efka dc 1500

CONTROL

AB220A5111

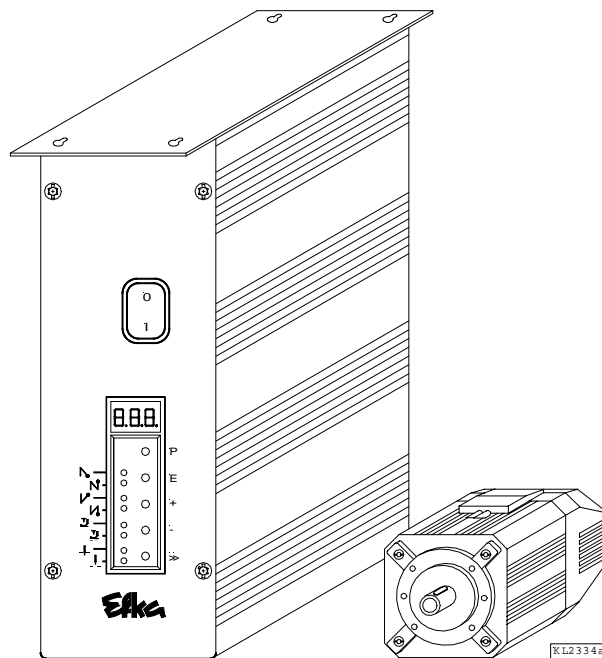

INSTRUCTION MANUAL

No. 402291

English

Efka
FRANKL & KIRCHNER
GMBH & CO KG

Efka
EFKA OF AMERICA INC.

Efka
EFKA ELECTRONIC MOTORS
SINGAPORE PTE. LTD.

CONTENTS	Page
1 Important Safety Instructions	7
2 Range of Applications	8
2.1 Use in Accordance with Regulations	9
3 Scope of Supply	9
3.1 Special Accessories	10
4 Control Operation without Control Panel	11
4.1 Access Authorization upon Command Input	11
4.2 Programming the Code Number	12
4.3 Parameter Selection	13
4.3.1 Direct Selection	13
4.3.2 Changing Parameter Values	14
4.3.3 Parameter Selection with the +/- Keys	15
4.3.4 Immediate Storage of All Changed Data	15
4.4 Changing All Parameter Values at the Operator Level	16
4.5 Function Switchover	16
4.6 Direct Input of Maximum Speed Limitation without Control Panel	16
4.7 Program Identification on the Control	17
5 Control Operation with Control Panel	18
5.1 Operation of the V810 Control Panel	18
5.1.1 Code Number Input on the V810 Control Panel	18
5.1.2 Parameter Input at the Operator Level on the V810 Control Panel	18
5.1.3 Parameter Input at the Technician/Supplier Level on the V810 Control Panel	19
5.2 V820 Control Panel Operation	19
5.2.1 Code Number Input on the V820 Control Panel	19
5.2.2 Parameter Input at the Operator Level on the V820 Control Panel	20
5.2.3 Parameter Input at the Technician/Supplier Level on the V820 Control Panel	20
5.3 Program Identification	21
5.4 Direct Input of Maximum Speed Limitation (DED) with Control Panel	21
5.4.1 Setting on the V810 Control Panel	21
5.4.2 Setting on the V820 Control Panel	21
5.5 Keys for Background Information (HIT) with V820	22
5.5.1 Example of HIT	22
5.5.2 Further Functions of the V810/V820 Control Panels	23
5.5.3 Special Functions of the V820 Control Panel	24
5.6 Programming of Seams (TEACH IN)	25
5.6.1 Programming after Code Number Input	26
5.6.2 Programming without Code Number Input	26
5.6.3 Detailed Example	28
5.6.4 Inserting a Seam or Pattern	29
5.6.5 Deleting a Seam or Pattern	30
5.6.6 Execution (Pattern) Mode	30
5.6.7 Further Settings for TEACH IN	30
6 Putting into Service	32
7 Setting and Putting into Service with the Aid of the Fast Installation Routine (SIR)	32
8 Setting the Basic Functions	34
8.1 Direction of Motor Rotation	34
8.2 Transmission Ratio	34
8.3 Selection of Functional Sequences (Thread Trimming Operations)	34
8.4 Functions of the Keys Inputs in1...i10	39

CONTENTS	Page
8.5 Positioning Speed	39
8.6 Maximum Speed Compatible with the Sewing Machine	39
8.7 Maximum Speed	39
8.8 Positions	40
8.8.1 Setting the Reference Position (Parameter 270 = 0)	42
8.8.2 Setting the Positions on the Control (Parameter 270 = 0)	42
8.8.3 Setting the Positions on the V810 Control Panel (Parameter 270 = 0)	43
8.8.4 Setting the Positions on the V820 Control Panel (Parameter 270 = 0)	43
8.9 Display of the Signal and Stop Positions	44
8.10 Positioning Shift	45
8.11 Braking Characteristics	45
8.12 Braking Power at Standstill	45
8.13 Starting Characteristics	45
8.14 Inputs for Proximity Switches	46
8.15 Actual Speed Display	46
9 Functions with or without Control Panel	47
9.1 Softstart	47
9.1.1 Softstart Speed	47
9.1.2 Softstart Stitches	47
9.2 Sewing Foot Lifting	47
9.3 Start Backtack/Start Stitch Condensing	49
9.3.1 Speed n3 at the Start of the Seam	49
9.3.2 Stitch Counting for Start Backtack/Start Stitch Condensing	49
9.3.3 Stitch Correction and Speed Release	50
9.3.4 Double Start Backtack	50
9.3.5 Single Start Backtack / Start Stitch Condensing	50
9.4 End Backtack / End Stitch Condensing	50
9.4.1 Speed n4 at the Seam End	51
9.4.2 Stitch Counting for End Backtack/End Stitch Condensing	51
9.4.3 Stitch Correction and Last Stitch Backward	51
9.4.4 Double End Backtack/End Stitch Condensing	51
9.4.5 Single End Backtack / End Stitch Condensing	51
9.4.6 Backtack Synchronization	52
9.5 Start Ornamental Backtack/Stitch Condensing	52
9.6 End Ornamental Backtack/Stitch Condensing	52
9.7 Intermediate Backtack	53
9.8 Stitch Regulator Suppression/Recall	53
9.9 Holding Power of the Stitch Regulator Solenoid	53
9.10 Reverse Motor Rotation	54
9.11 Unlocking the Chain (Mode 4/5/6/7/16)	54
9.12 Machine Run Blockage (Safety Switch)	55
9.13 High Lift for Walking Foot Signal Output M6 / Flip-Flop 1	56
9.13.1 High Lift Walking Speed	56
9.13.2 High Lift Walking Speed Run-Out Time	56
9.13.3 High Lift Walking Stitches	57
9.13.4 High Lift for Walking Foot Operational Mode Not Stored (Parameters 240...249 = 13)	57
9.13.5 High Lift for Walking Foot Operational Mode Stored /Flip-Flop 1 (Parameters 240...249 = 14)	57
9.14 Speed Depending on High Lift	57
9.14.1 Operating Mode of Speed Limitation Depending on High Lift	57
9.14.2 Setting the Speed Limitation Depending on High Lift with the V820 Control Panel	58
9.14.3 Setting the Speed Limitation Depending on High Lift with the V810 Control Panel	59
9.14.4 Potentiometer Adjustment on JUKI Machine Model LU-2210/LU2260	60
9.15 Speed Limitation n9	60
9.16 Speed Limitation n11 with Signal Output M10 / Flip-Flop 2	60
9.17 Disabling of Flip-Flop Functions at the Seam End	61

CONTENTS	Page
9.18 Bobbin Thread Monitor	61
9.19 Thread Trimming Operation	62
9.19.1 Thread Trimmer/Thread Wiper (Modes 0, 2, 3, 10, 14, 20 and 23)	62
9.19.2 Trimming Speed	62
9.19.3 Chainstitch Thread Trimmer (Modes 4, 5, 6, 21 and 24)	62
9.19.4 Chainstitch Machine Trimming Signal Times	63
9.20 Bag Sewing Machine Functions (Mode 5)	63
9.21 Stitch Lock Machine Functions (Mode 21)	63
9.22 Functions for Pegasus MHG-100 Machine (Mode 24)	64
9.23 Overlock Machine Functions (Mode 7)	64
9.23.1 Chain Suction Signal	64
9.23.2 Start and End Counts	65
9.24 Function of Output Signal M8	65
9.25 Function of Output Signal M11	66
9.26 Tape Cutter/Fast Scissors (Modes 6/7/15/16)	66
9.26.1 Functions for Mode 6	66
9.26.2 Functions for Mode 7	66
9.26.3 Functions for Mode 15	67
9.26.4 Functions for Mode 16	68
9.27 Manual Tape Cutter/Fast Scissors	69
9.28 Manual Stacker	70
9.29 Selection of Signals M8, M9 and M10 at the Start of the Seam	70
9.30 Seam with Stitch Counting	70
9.30.1 Stitches for Stitch Counting	70
9.30.2 Stitch Counting Speed	71
9.30.3 Seam with Stitch Counting When Light Barrier Is On	71
9.31 Free Seam and Seam with Light Barrier	71
9.32 Light Barrier	72
9.32.1 Speed after Light Barrier Sensing	72
9.32.2 General Light Barrier Functions	72
9.32.3 Reflection Light Barrier LS002	73
9.32.4 Light Barrier Monitoring	73
9.32.5 Automatic Start Controlled by Light Barrier	73
9.32.6 Light Barrier Filter for Knitted Fabrics	73
9.32.7 Functional Variations of the Light Barrier Input	74
9.33 Switching Functions of Inputs in1...i10	74
9.34 Software Debouncing of All Inputs	75
9.35 F1/F2 Function Key Assignment on the V810/V820 Control Panels	75
9.36 Functioning of Handwheel when Pressing a Key	76
9.37 Speed Limitation by means of External Potentiometer	76
9.38 Signals A1 and A2	77
9.39 Signal "Machine Running"	79
9.40 Signal Output Position 1	79
9.41 Signal Output Position 2	79
9.42 Signal Output 512 Impulses per Rotation	80
9.43 Actuator	80
9.44 Audible Signal	81
10 Signal Test	81
10.1 Signal Test Using the Incorporated Control Panel or the V810/V820	81
11 Error Displays	83
12 Operating Elements of the V810 Control Panel	84
13 Operating Elements of the V820 Control Panel	85

1 Important Safety Instructions

When using an EFKA drive and accompanying devices (e.g. for sewing machines), basic safety precautions should always be followed, including the following:

- Read all instructions thoroughly before using this drive.
- Drive, its accessories and accompanying devices should be mounted and put into operation by qualified personnel in accordance with the guidelines provided in the instruction manual.

To reduce the risk of burns, fire, electric shock, or personal injury:

- Use this drive only for its intended use as described in the instruction manual.
- Use only attachments recommended by the manufacturer or as contained in the instruction manual.
- Do not operate without corresponding protective devices.
- Never operate this drive if one or more parts (e.g. cables, plugs) are damaged, if it is not working properly, if any damages can be identified or are to be suspected (e.g. after it has been dropped). Only qualified personnel are authorized to make adjustments, eliminate faults and complete repair work.
- Never operate the drive with the air openings blocked. Keep ventilation openings of the drive free from the accumulation of lint, dust and loose cloth.
- Never drop or insert any object into any opening.
- Do not use drive outdoors.
- Do not operate where aerosol (spray) products are being used or where oxygen is being administered.
- To disconnect, turn off main switch, then remove plug from outlet.
- Do not unplug by pulling on cord. To unplug, grasp the plug, not the cord.
- Keep fingers away from all moving machine parts. Special care is required e.g. around the sewing machine needle and the V-belt.
- Before mounting and adjusting accompanying devices, i.e. position transmitter, reversing device, light barrier, etc., disconnect drive from mains (turn off main switch, remove mains plug from outlet [DIN VDE 0113 part 301; EN 60204-3-1; IEC 204-3-1]).
- Always switch off (0) machine and remove plug from outlet, when removing covers, mounting accompanying devices, position transmitter especially, light barrier, etc., or any other devices mentioned in the instruction manual.
- Only qualified personnel are authorized to work on the electrical components.

- Work on high voltage circuit areas is forbidden, except as stated in the respective regulations, e.g. DIN VDE 0105 part 1.
- Only specially trained personnel are authorized to complete repair work.
- Cables to be wired must be protected against expectable strain and fastened adequately.
- Cables near moving machine parts (e.g. V-belts) must be wired at a minimum distance of 25 mm (see DIN VDE 0113 part 301; EN 60204-3-1; IEC 204-3-1).
- For safety it is preferred to wire the cables separately from each other.
- Before connecting the mains line make sure that the mains voltage corresponds to the specifications on the motor rating plate and on the nameplate of the power pack.
- Connect this drive to a properly grounded outlet only. See Grounding Instructions.
- Electric accompanying devices and accessories must only be connected to safety low voltage.
- EFKA DC drives are protected according to overvoltage class 2 (DIN VDE 0160 § 5.3.1).
- Observe all safety guidelines before undertaking conversions or modifications.
- For repair and maintenance use only original replacement parts.



Warnings in the instruction manual which point out particular risks of personal injury or risk to the machine are marked with this symbol wherever applicable.



This symbol is a warning on the control and in the instruction manual. It indicates hazardous voltage.

CAUTION – In the case of failure this area can be current-carrying even after having turned the power off (non discharged capacitors).

- The drive is not an independently operating unit, but is designed to be incorporated into other machinery. It must not be put into service until the machinery into which it is to be incorporated has been declared in conformity with the provisions of the EC Directive.

Save these instructions for future reference.

2 Range of Applications

The drive is suitable for lockstitch, chainstitch and overlock machines of various manufacturers. Furthermore, stepping motor operation is possible with the SM210A control. See connection scheme in the List of Parameters.

With the help of adapter cords (adapter cords see Special Accessories), the drive can be used with the following controls replacing previous models:

Machine manufacturer	Replacing	Machine	Model	Thread trimming mode	Adapter cord
Aisin	AB62AV	Lockstitch	AD3XX,AD158 3310,EK1	0	1112815
Brother	AB62AV	Lockstitch	737-113,737-913	0	1112814
Brother	AC62AV	Chainstitch	FD3 B257	5	1112822
Dürkopp Adler	DA62AV	Lockstitch	210,270	0	1112845
Global		Chainstitch	CB2803-56	5	1112866
Juki	AB62AV	Lockstitch	5550-6	14	1112816
Juki	AB62AV	Lockstitch	5550-7	14	1113132
Juki	LU1510-7	Lockstitch		20	1113200
Kansai	AC62AV	Chainstitch	RX 9803	5	1113130
Pegasus	AC62AV	Chainstitch	W500/UT W600/UT/MS with/without stitch condensing	5	1112821
Pegasus	AB60C	Backlatch		8	1113234
Pegasus		Chainstitch	MHG-100	24	1113267
Pfaff	PF62AV	Lockstitch	563,953,1050, 1180	0	1112841
Rimoldi		Chainstitch	F27	5	1113096
Singer	SN62AV	Lockstitch	212 UTT	2	1112824
Union Special	US80A	Lockstitch	63900AMZ	10	1112823
Union Special	US80A	Chainstitch	34000, 36200	4	1112865
Union Special	AC62AV	Chainstitch	34700 with stitch lock	5	1112844
Union Special	US80A	Chainstitch	CS100, FS100	4	1112905
Yamato	AC62AV	Chainstitch	VC series	5	1112818
Yamato		Chainstitch	VG series	5	1113178
Yamato	AB60C	Backlatch	ABT3	9	1112826
Yamato		Backlatch	ABT13, ABT17	9	1113205
Yamato		Chainstitch	Stitch lock	21	1113178

2.1 Use in Accordance with Regulations

The drive is not an independently operating machine, but is designed to be incorporated into other machinery. It must not be put into service until the machinery into which it is to be incorporated has been declared in conformity with the provisions of the EC Directive (Appendix II, paragraph B of the Directive 89/392/EEC and supplement 91/368/EEC).

The drive has been developed and manufactured in accordance with the relevant EC standards:

EN 60204-3-1:1990 Electrical equipment of industrial machines:
Particular requirements for industrial sewing machines, sewing units and sewing systems.

- Operate the drive only in dry areas.



CAUTION

When selecting the installation site and the layout of the connecting cable, the Safety Instructions in chapter 1 must be followed with no exceptions. Particular attention should be paid to maintaining the proper distance from moving parts!

3 Scope of Supply

1	Direct current motor	DC1500
1	Electronic control - Power pack	AB220A5111 N201
1	Actuator	EB301A
1	Set of standard accessories consisting of:	B156 standard Plastic bag for B156 Documentation
	or	
1	Set of standard accessories consisting of:	B159 optional Bracket DC1500 Plastic bag for B159 Normal mounting foot Belt guard, complete Support + Mounting material Documentation Pulley A71-L Adapter ring
1	Set of accessories consisting of:	Z53 Pitman rod 400...700mm long 37-pin SubminD plug Potential equalization cord Bracket for fastening EB3..

Note

If there is no metallical contact between drive (motor) and machine head, the potential equalization cord supplied with the unit is to be wired from the machine head to the terminal provided on the control box!

3.1 Special Accessories

Control panel Variocontrol V810	- part no. 5970153
Control panel Variocontrol V820	- part no. 5970154
Reflection light barrier module LSM002	- part no. 6100031
Hall sensor module HSM001	- part no. 6100032
Pulse encoder IPG001	- part no. 6100033
EFKANET interface IF232-2, complete	- part no. 7900068
Adapter cord for the connection of the control to interface 232-2	- part no. 1113119
Adapter cord for the connection of sockets B18 each on the SM210 stepping motor control and on the above control (see chapter "Connection Scheme of SM210A Stepping Motor Control" in the List of Parameters)	- part no. 1113172
Actuating solenoid type EM1.. (for e. g. sewing foot lifting, backtacking, etc.)	- see specification "solenoids" for available models
Fitting piece for position transmitter	- part no. 0300019
Knee switch type KN3 (pushbutton) with cord of approx. 950 mm length without plug	- part no. 5870013
Adapter cord for the connection to AISIN high-speed seamer AD3XX, AD158, 3310 and overlock machine EK1	- part no. 1112815
Adapter cord for the connection to BROTHER models 737-113, 737-913	- part no. 1112814
Adapter cord for the connection to BROTHER chainstitch machine model FD3 B257	- part no. 1112822
Adapter cord for the connection to BROTHER sewing machines with position sensor incorporated in the handwheel	- part no. 1113213
Adapter cord for the connection to DÜRKOPP ADLER models 210 and 270	- part no. 1112845
Adapter cord for the connection to GLOBAL model CB2803-56	- part no. 1112866
Adapter cord for the connection to JUKI high-speed seamer with index -6	- part no. 1112816
Adapter cord for the connection to JUKI high-speed seamer with index -7	- part no. 1113132
Adapter cord for the connection to JUKI lockstitch machines with position sensor incorporated in the handwheel	- part no. 1113157
Adapter cord for the connection to JUKI high-speed seamer model LU1510-7	- part no. 1113200
Adapter cord for the connection to KANSAI machine model RX 9803	- part no. 1113130
Adapter cord for the connection to PEGASUS models W500/UT, W600/UT/MS with or without stitch condensing	- part no. 1112821
Adapter cord for the connection to PEGASUS backlatch machine	- part no. 1113234
Adapter cord for the connection to PEGASUS chainstitch machine MHG-100	- part no. 1113267
Adapter cord for the connection to PFAFF models 563, 953, 1050, 1180	- part no. 1112841
Adapter cord for the connection to RIMOLDI model F27	- part no. 1113096
Adapter cord for the connection to SINGER models 211, 212U, 212UTT and 591	- part no. 1112824
Adapter cord for the connection to UNION SPECIAL lockstitch machine model 63900AMZ (as a replacement for the US80A)	- part no. 1112823
Adapter cord for the connection to UNION SPECIAL model 34700 with stitch lock	- part no. 1112844
Adapter cord for the connection to UNION SPECIAL models 34000 and 36200 (as a replacement for the US80A)	- part no. 1112865
Adapter cord for the connection to UNION SPECIAL models CS100 and FS100	- part no. 1112905
Adapter cord for the connection to YAMATO VC series chainstitch machines	- part no. 1112818
Adapter cord for the connection to YAMATO VG series chainstitch machines	- part no. 1113178
Adapter cord for the connection to YAMATO backlatch machine ABT3	- part no. 1112826
Adapter cord for the connection to YAMATO backlatch machines ABT13, ABT17	- part no. 1113205
Extension cable approx. 1000 mm long for commutation transmitter DC15..	- part no. 1113151
Extension cable approx. 1000 mm long for DC15.. line	- part no. 1113150
Adapter cord for the connection of both light barrier module and Hall sensor module or EFKANET	- part no. 1113229
Mounting kit for DC1500 on PEGASUS model W600	- part no. 1113125
Mounting kit for DC1500 on PEGASUS Ex/Ext	- part no. 1113126
Undertable mounting kit for DC15..	- part no. 1113235
Sewing light transformer	- please indicate line voltage and sewing light voltage (6,3V or 12V)
9-contact SubminD male connector	- part no. 0504135
9-contact SubminD male connector	- part no. 0504136
Half-shell housing for 9-contact SubminD	- part no. 0101523
37-pin SubminD male connector, complete	- part no. 1112900
Single pins for 37-pin SubminD with strand of 5cm length	- part no. 1112899

4 Control Operation without Control Panel

4.1 Access Authorization upon Command Input

In order to prevent unintentional changes of preset functions the command input is distributed at various levels.

- The following persons have access:**
- the supplier to the highest and all subordinate levels by means of a code number
 - the technician to the next lower and all subordinate levels by means of a code number
 - the operator to the lowest level without code number

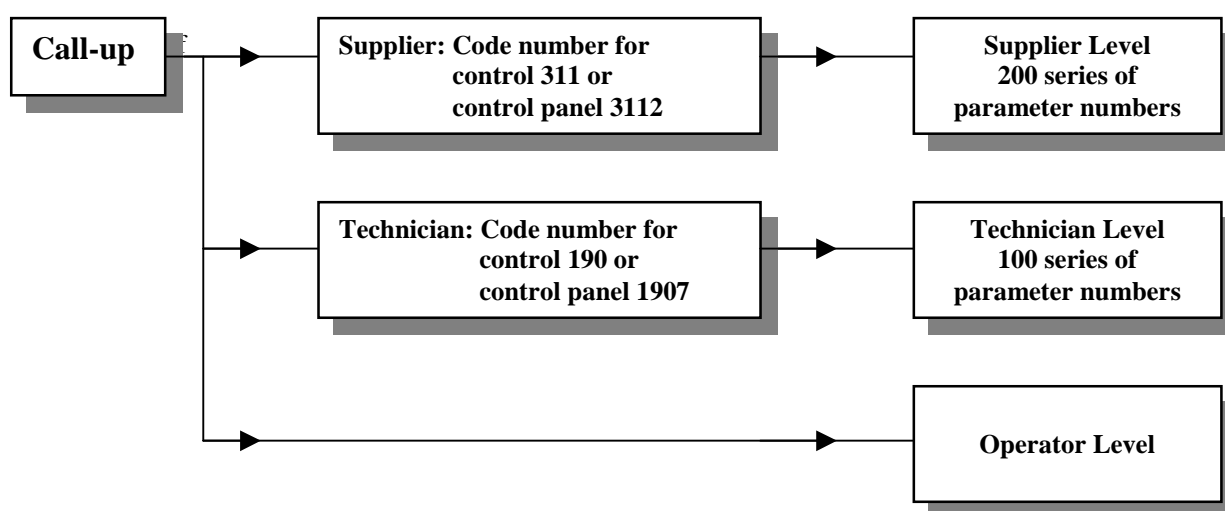

4.2 Programming the Code Number

Note
The parameter numbers in the illustrations below serve as examples and may not be available in all program versions.
In this case, the display shows the next higher parameter number. See List of Parameters.

1. Press the **P** key and turn power on

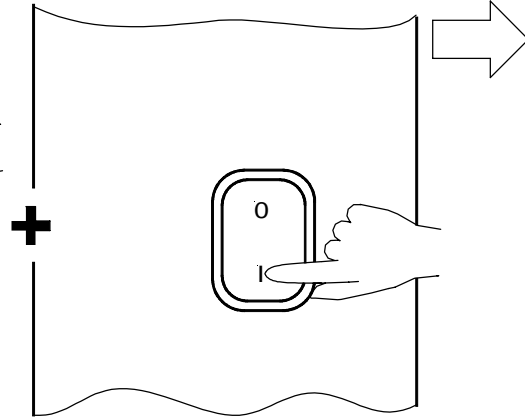
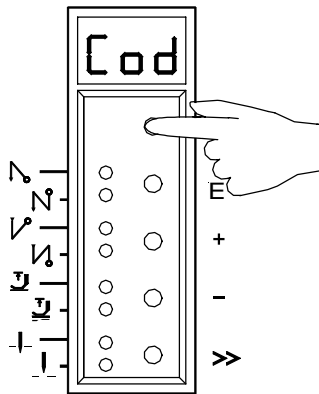

2. Press the **>>** key (1st digit blinks)

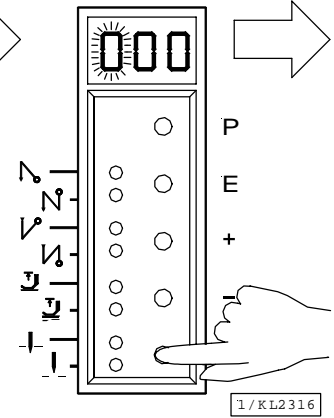

3. Press the **+** or **-** key to select the 1st digit
Technician level → Code no. 190
Supplier level → Code no. 311

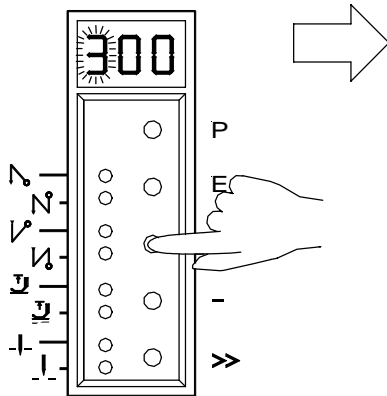

4. Press the **>>** key (2nd digit blinks)

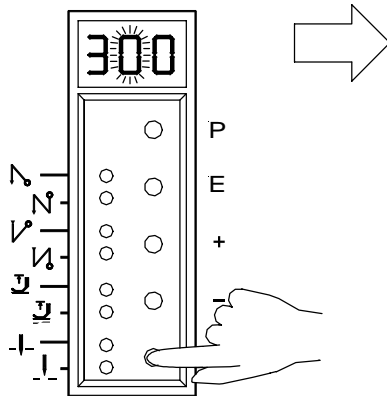

5. Press the **+** or **-** key to select the 2nd digit

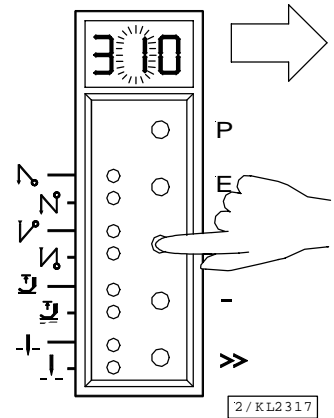

6. Press the **>>** key (3rd digit blinks)

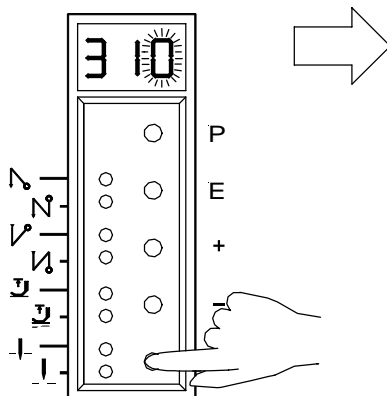

7. Press the **+** or **-** key to select the 3rd digit

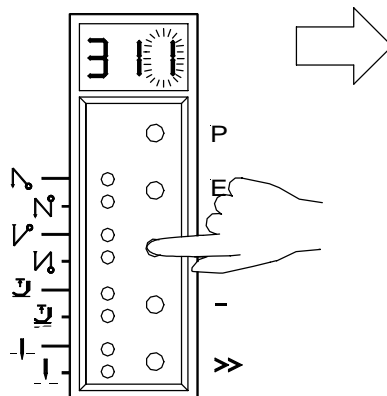

8. Press the **E** key; the parameter number is displayed, which is indicated by points between the digits.

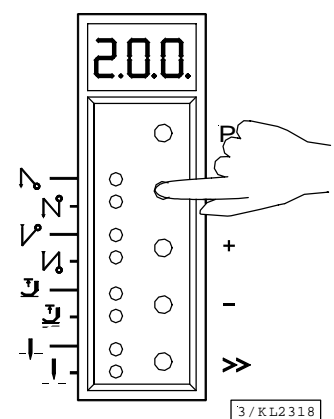

4.3 Parameter Selection

4.3.1 Direct Selection

1. After code number input at the programming level

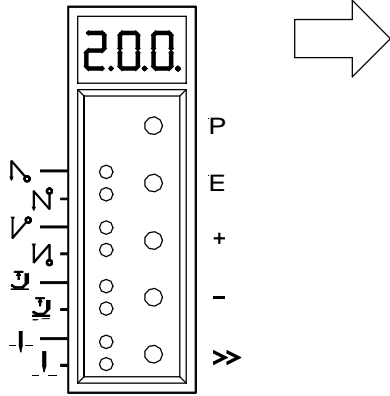

2. Press the >> key (1st digit blinks)

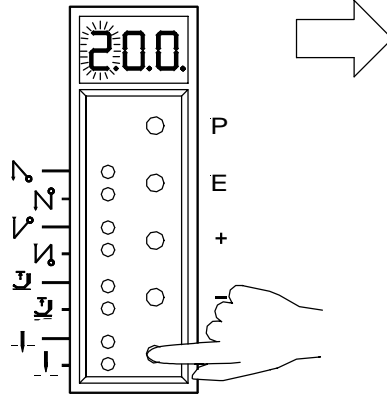

3. Press the + or - key to select the 1st digit

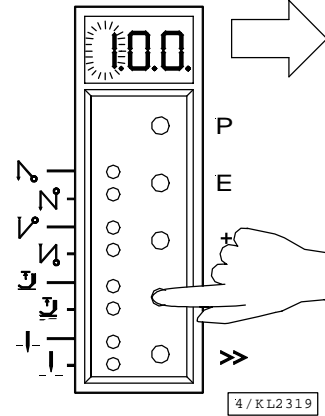

4. Press the >> key (2nd digit blinks)

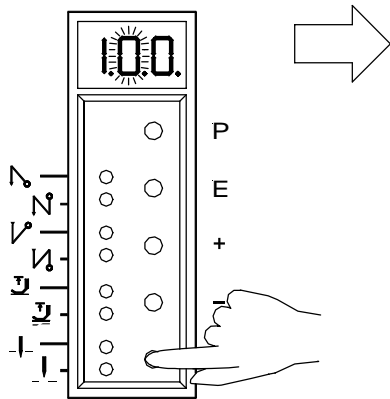

5. Press the + or - key to select the 2nd digit

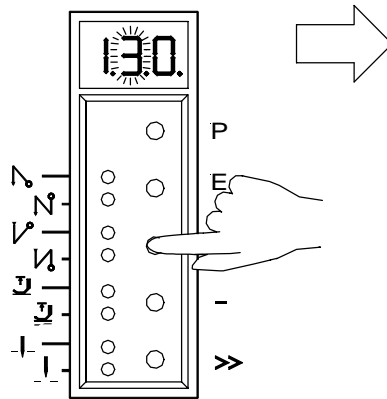

6. Press the >> key (3rd digit blinks)

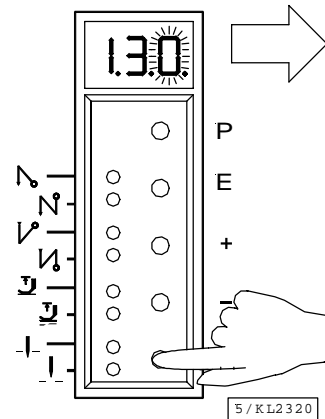

7. Press the + or - key to select the 3rd digit

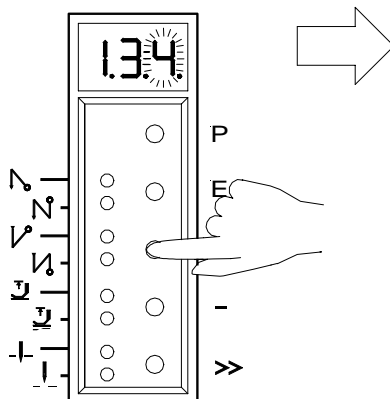

8. Press the E key; the parameter value is displayed. There are no points between the digits.

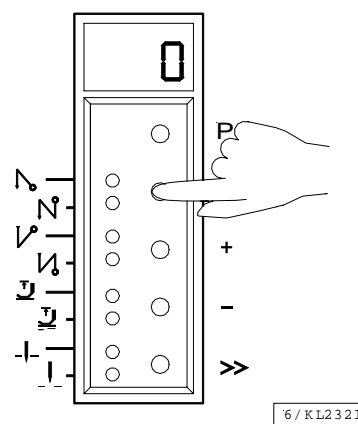

4.3.2 Changing Parameter Values

1. Display after parameter value selection

2. Change the parameter value by pressing the + or - key

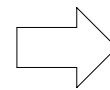
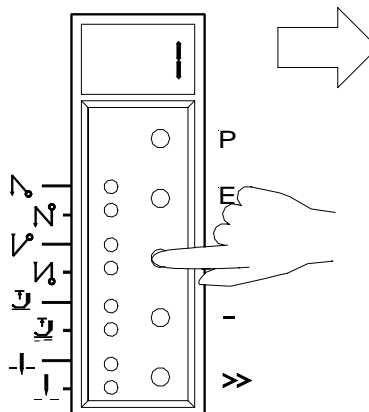
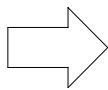
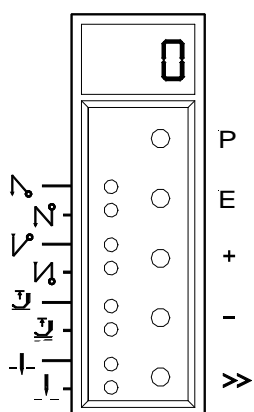

7 / KL2322

Option 1

Press the **E** key. The **next** parameter number is displayed.

Press the **P** key. Exit programming. The changed parameter values will be saved when you start sewing again!

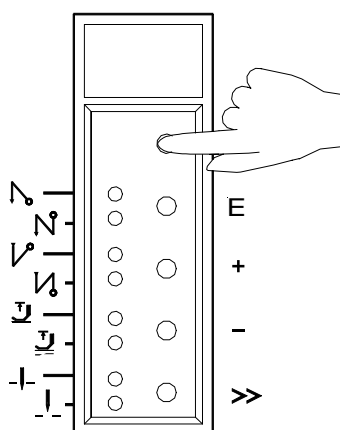
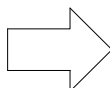
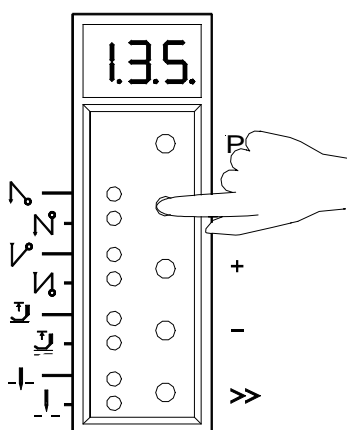

8 / KL2323

Option 2

Press the **P** key. The **same** parameter number is displayed.

Press the **P** key. Exit programming. The changed parameter values will be saved when you start sewing again!

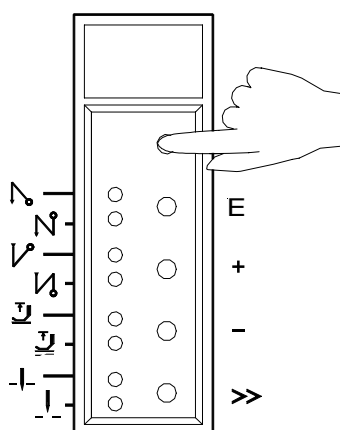
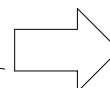
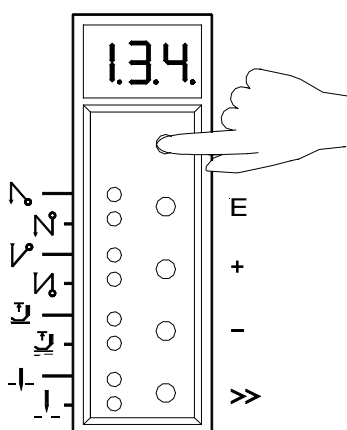

9 / KL2324

4.3.3 Parameter Selection with the +/- Keys

1. After code number input at the programming level

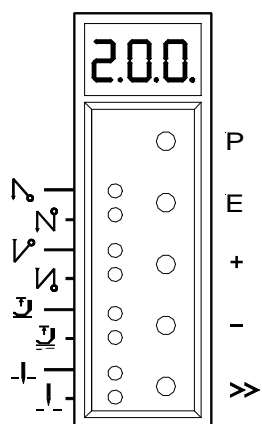

10/KL2325

2. Select the next parameter by pressing the + key

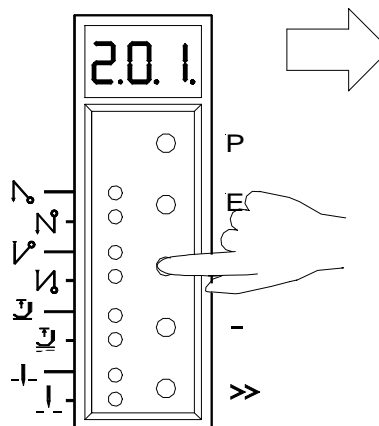

3. Select the previous parameter by pressing the - key

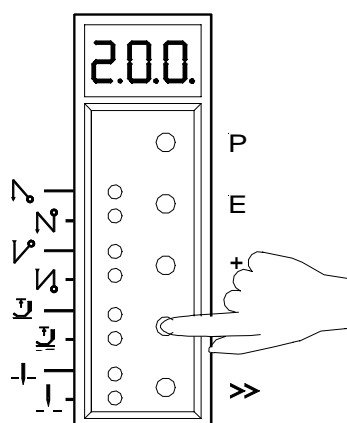

11/KL2326

4. After pressing the E key, the parameter value is displayed

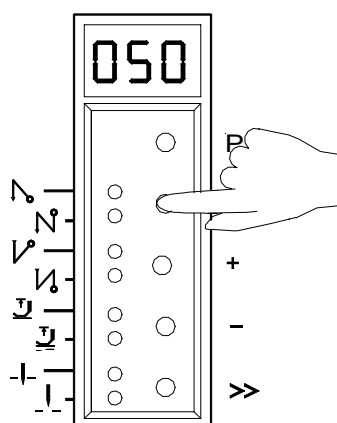

These values are saved when you start sewing. They remain in effect even after turning the machine off!
Another possibility is using parameter 401 for immediate storage without having to start sewing.

4.3.4 Immediate Storage of All Changed Data

Functions	Parameter
Immediate storage of all changed data	(EEP) 401

- Input code number 3112 after power On
 - Input parameter 401
 - Set display from **0** to **1**
 - All data are stored!
- ➔ Taste **E** betätigen
 - ➔ Taste **E** betätigen
 - ➔ Taste **E** oder **P** betätigen

4.4 Changing All Parameter Values at the Operator Level

All parameter values at the operator level can be changed without code number input (see List of Parameters).

- Press the **P** key → The first parameter number will be displayed
- Press the **E** key → The parameter value will be displayed
- Press the +/- keys → The parameter value will be changed
- Press the **E** key → The next parameter will be displayed
- Press the **E** key → The parameter value will be displayed
- Press the +/- keys → The parameter value will be changed etc.
- Press the **P** key twice → Exit programming at the operator level

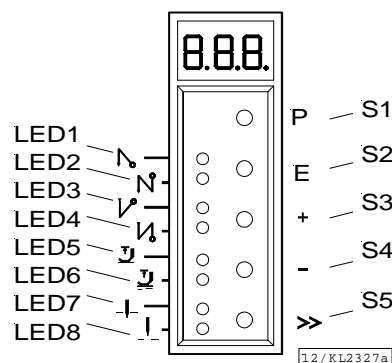

4.5 Function Switchover

Switchable functions can be changed by pressing the appropriate key. The switching state is indicated by light emitting diodes (LED). See above illustration!

Table: Assignment of functions to keys and LEDs

Function	Key	LED number
Single start backtack / Chain suction at the start of the seam	E (S2)	1 = on 2 = off
Double start backtack / Chain suction at the seam end	E	1 = off 2 = on
Start backtack Off / Chain suction at the start of the seam / seam end	E	1 = on 2 = on
Chain suction Off	E	1 = off 2 = off
Single end backtack / Tape cutter at the start of the seam	+ (S3)	3 = on 4 = off
Double end backtack / Tape cutter at the seam end	+	3 = off 4 = on
End backtack Off / Tape cutter at the start of the seam / seam end	+	3 = on 4 = on
Tape cutter Off	+	3 = off 4 = off
Sewing foot lift at stop in the seam (automatic)	- (S4)	5 = on 6 = off
Sewing foot lift at the seam end (automatic)	-	5 = off 6 = on
Sewing foot lift at stop in the seam and at the seam end (automatic)	-	5 = on 6 = on
Sewing foot lift (automatic) Off	-	5 = off 6 = off
Basic position down (position 1)	>> (S5)	7 = on 8 = off
Basic position up (position 2)	>>	7 = off 8 = on

4.6 Direct Input of Maximum Speed Limitation without Control Panel

The maximum speed of the machine must be limited to the specific level according to the application. Do the setting at the operator level on the control by means of the +/- keys during operation or at intermediate machine stop. This function is blocked at the start of the seam or after the seam end. The actual value shown on the display must be multiplied by 10. When using a control panel, the full speed value is displayed. See also chapter 5.4!

Example:

The value 330 on the control display corresponds to a speed of 3300 RPM.

Important! If the speed is changed, it is saved only after trimming and when you start sewing again.

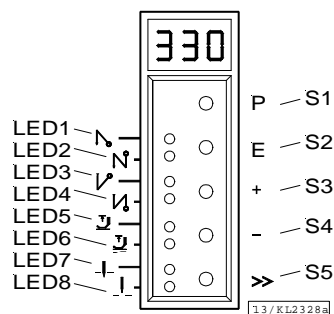

4.7 Program Identification on the Control

Function without control panel	Parameter
Program number, modification index and identification number display	179

After having selected parameter 179, the following information is displayed in succession:

1. Select parameter **179**.

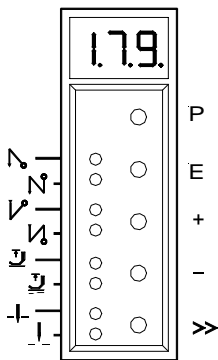

2. Press the **E** key.
Abbreviation **Sr5** is displayed.

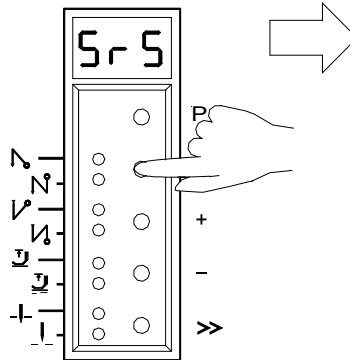

3. Press the **>>** key.
The first 2 digits of the program number are displayed.

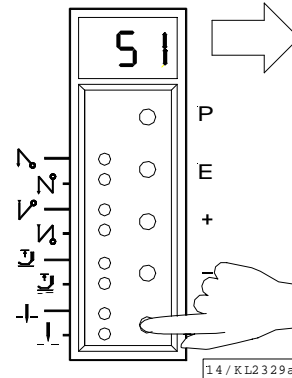

4. Press the **E** key.
The second 2 digits of the program number are displayed.

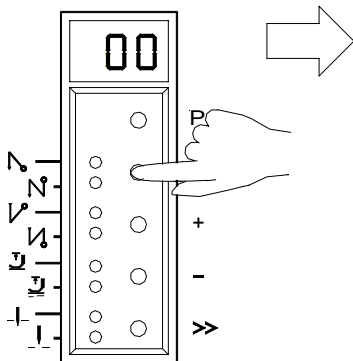

5. Press the **E** key.
The program modification index is displayed.

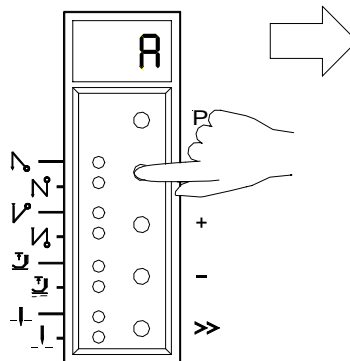

6. Press the **E** key.
The identification number digits 1 and 2 are displayed.

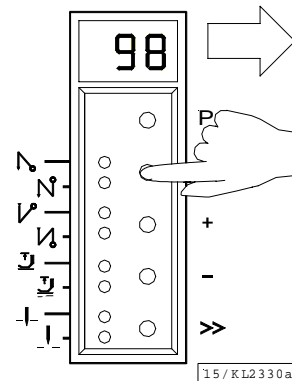

7. Press the **E** key.
The identification number digits 3 and 4 are displayed.

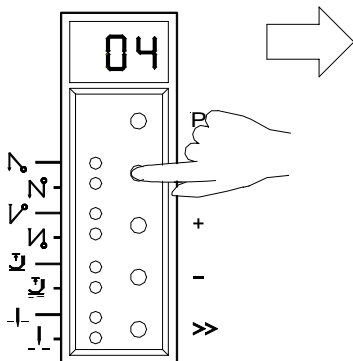

8. Press the **E** key.
The identification number digits 5 and 6 are displayed.

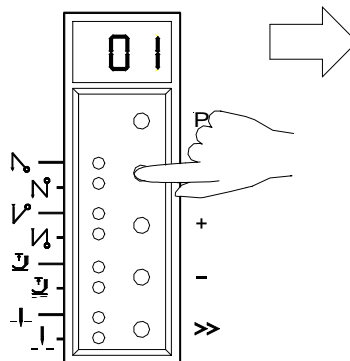

9. Press the **E** key.
The identification number digits 7 and 8 are displayed.

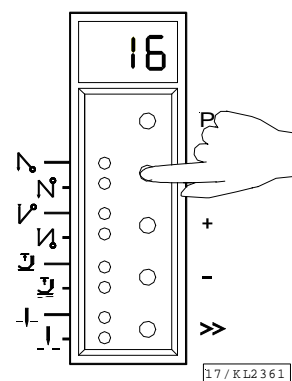

The routine is repeated after pressing the **E** key. Exit the routine after pressing the **P** key once. The next parameter number is displayed. Exit programming after pressing the **P** key. The drive is again ready for sewing.

5 Control Operation with Control Panel

5.1 Operation of the V810 Control Panel

5.1.1 Code Number Input on the V810 Control Panel

Technician Level Code Number => 1907 and Supplier Level Code Number => 3112

Example: Technician level CODE number selection on the V810 control panel

		TURN POWER OFF		
P	+	TURN POWER ON. First digit blinks !	→	C - 0 0 0 0
+	-	Press the + or - key to select the first digit !	→	C - 1 0 0 0
>>		Press the >> key ! Second digit blinks !	→	C - 1 0 0 0
+	-	Press the + or - key to select the second digit !	→	C - 1 9 0 0
>>	>>	Press the >> key twice ! Fourth digit blinks !	→	C - 1 9 0 0
+	-	Press the + or - key to select the fourth digit!	→	C - 1 9 0 7
E		If the CODE number is correct, the first PARAMETER number at the selected level is displayed !	→	F - 1 0 0

5.1.2 Parameter Input at the Operator Level on the V810 Control Panel

Example: CODE number has not been input !

		TURN POWER ON !	→	A b 2 2 0 A
P		First parameter at the operator level is displayed.	→	F - 0 0 0
+		Second parameter at the operator level is displayed. The next or previous parameter can be called by pressing the +/- keys.	→	F - 0 0 1
E		Parameter value is displayed !	→	0 0 3
+		Change parameter value by pressing the +/- keys.	→	X X X
E		Parameter value is entered. Display advances to the next parameter.	→	F - 0 0 2
+		Press the + key several times until the desired parameter is displayed !	→	F - 0 0 9
E		Parameter value is displayed !	→	0

+	New parameter value is displayed !	→	1
E	Next parameter is displayed !	→	F - 0 1 3
or			
P	Exit programming !	→	A b 2 2 0 A

These values are saved when you start sewing. They remain in effect even after turning the machine off! Another possibility is using parameter 401 for immediate storage without having to start sewing.

Note! The parameter number can also be selected directly, like the code number!

5.1.3 Parameter Input at the Technician/Supplier Level on the V810 Control Panel

Example: After CODE number input at the technician level.

	After CODE number input, the first PARAMETER number is displayed!	→	F - 1 0 0
+	Press the + key ! The next parameter number is displayed !	→	F - 1 1 0
E	Press the E key ! The parameter value is displayed !	→	0 1 8 0
+ -	Change the parameter value !	→	0 X X X
E	Parameter value is entered. Display advances to the next parameter.	→	F - 1 1 1
or			
P	Parameter value is entered. The actual PARAMETER number is displayed!	→	F - 1 1 0
or			
P P	Press the P key twice ! Exit programming !	→	A b 2 2 0 A

These values are saved when you start sewing. They remain in effect even after turning the machine off! Another possibility is using parameter 401 for immediate storage without having to start sewing.

5.2 V820 Control Panel Operation

5.2.1 Code Number Input on the V820 Control Panel

Technician Level Code Number => 1907 and Supplier Level Code Number => 3112

Example: Technician level CODE number selection on the V820 control panel

	TURN POWER OFF !		
P	+	TURN POWER ON !	→
			C-0000
1	9	0	7
		Input CODE number !	→
			C-1907

E	If CODE number is incorrect, repeat input !	→	C-0000 InFo F1
E	If CODE number is correct, the first PARAMETER number at the selected level is displayed.	→	F-100

5.2.2 Parameter Input at the Operator Level on the V820 Control Panel

Example: CODE number has not been input !

	TURN POWER ON !	→	4000 Ab220A
P	Display shows no reading !	→	
E	First parameter at the operator level is displayed. PARAMETER number is not displayed.	→	c2 003
+	-	→	c2 XXX
E	Parameter value is entered. Display advances to the next parameter.	→	c1 003
or			
P	Exit programming !	→	4000 Ab220A

5.2.3 Parameter Input at the Technician/Supplier Level on the V820 Control Panel

Example: After CODE number input at the technician level.

	After CODE number input, the first PARAMETER number is displayed.	→	F-100
E	The most significant digit of the PARAMETER number blinks.	→	F-100
1	1	0	Input desired PARAMETER number!
		→	F-110
E	If PARAMETER number is incorrect, repeat input!	→	F-XXX InFo F1
E	If PARAMETER number is correct	→	F-110 n1 180
+	-	→	F-110 n1 XXX
E	Parameter value is entered. Display advances to the next parameter.	→	F-111 n2- 4000
or			
P	Parameter value is entered. A new PARAMETER number can be selected.	→	F-XXX
or			
P	P	→	4000 Ab220A

These values are saved when you start sewing. They remain in effect even after turning the machine off! Another possibility is using parameter 401 for immediate storage without having to start sewing.

5.3 Program Identification

Function with control panel	Parameter
Program number, modification index and identification number display	179

Display example parameter 179 on the V810 control panel:

- Select parameter 179!
- Press the **E** key → **Sr5 [°]** is displayed
- Press the >> key → e. g. **5111A** is displayed (Program number with index)
- Press the **E** key → e. g. **010823** is displayed (1st part of identification number)
- Press the **E** key → e. g. **15** is displayed (2nd part of identification number)
- Press the **P** key twice → **Ab220A** is displayed (Sewing process can be started)

Display example parameter 179 on the V820 control panel:

- Select parameter 179!
- Press the **E** key → **F-179 Sr5 [°]** is displayed
- Press the >> key → e. g. **5111A** is displayed (Program number with index)
- Press the **E** key → e. g. **01082315** is displayed (Identification number)
- Press the **P** key twice → **Ab220A** is displayed (Sewing process can be started)

5.4 Direct Input of Maximum Speed Limitation (DED) with Control Panel

The maximum speed of the machine must be limited to the specific level according to the application. Do the setting at the operator level by means of the +/- keys at any time. The actual value is shown on the display. The speed setting range is between parameter 111 (upper limit) and parameter 121 (lower limit).

5.4.1 Setting on the V810 Control Panel

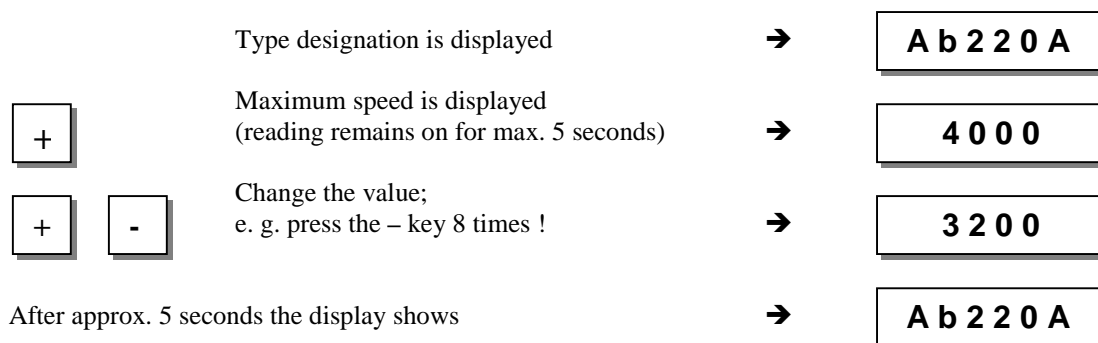

5.4.2 Setting on the V820 Control Panel

Actual display value, in the direct mode

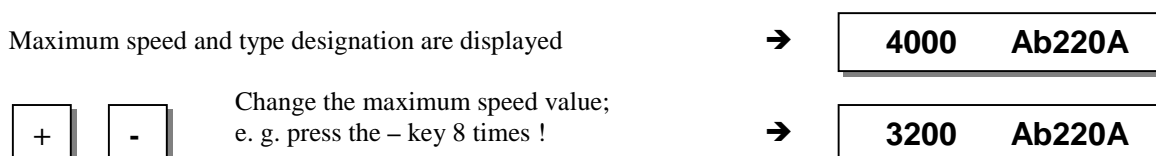

Note

Changing the setting of the maximum speed limitation also affects the start backtack, end backtack and stitch counting speeds.

5.5 Keys for Background Information (HIT) with V820

(key assignment see figure on the last page)

Note

The following functions are possible only with the V820 control panel!

For fast operator information, the values of functions switched on by means of the 1, 2, 3, 4 and 9 keys are displayed on the control panel for approx. 3 seconds. During this time, the respective values can be varied directly by pressing the + or - key.

5.5.1 Example of HIT

Increase stitch-count seam section from 20 stitches to 25 stitches.

Stitch-count function (2 key) is off.

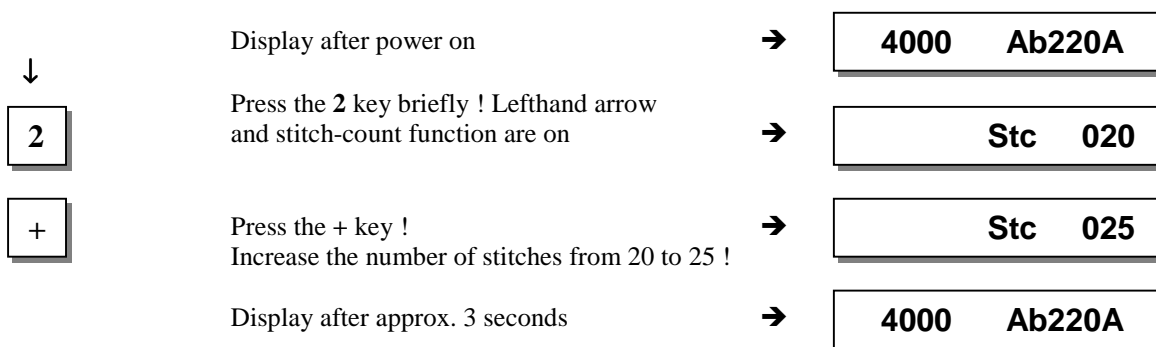

Stitch-count function (2 key) is already on.

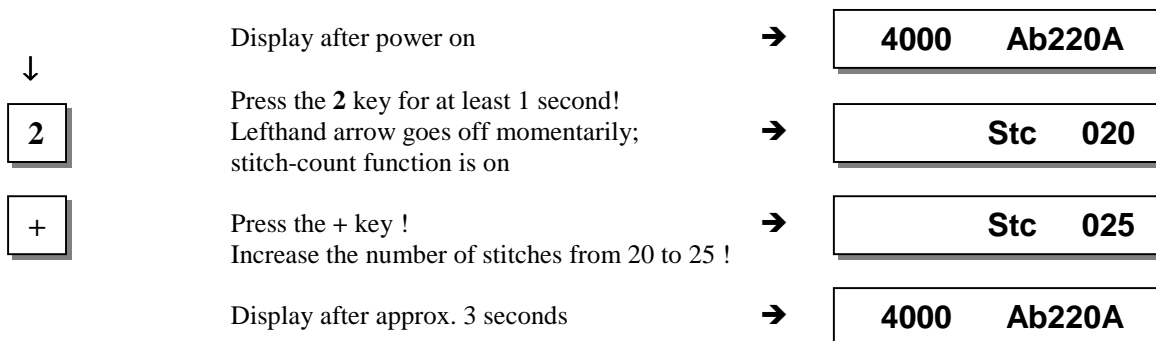

**This value is saved when you start sewing. It remains in effect even after turning the machine off!
Another possibility is using parameter 401 for immediate storage without having to start sewing.**

Function key F

Various parameters, even higher-level parameters, can be switched on or off by pressing the function key (9 key).
The following functions may be assigned to the function key:

1. Softstart ON/OFF
2. Ornamental backtack ON/OFF
3. Sewing start blocked with light barrier uncovered ON/OFF
4. Unlocking the chain ON/OFF
5. Signals A1 and/or A2 On/Off with slide-in strips 1...4 (lefthand arrow = A1, righthand arrow = A2)

The key assignment can be changed as follows:



E	Press the E key!	→	c2 002
E	Press the E key several times until the letter symbol -F- appears ! (ornamental backtack On/Off)	→	-F- 2
-	Press the - key! (softstart On/Off)	→	-F- 1
P	Press the P key!	→	4000 Ab220A

The assignment is completed.

The number of softstart stitches can be changed as follows:

Example: change number of stitches from 1 to 3 (softstart function (9 key) is off).

9	Press the 9 key briefly ! The arrow above the key lights up (softstart function is On)	→	SSc 001
+	Press the + key ! Number of stitches increases.	→	SSc 003
	Display after 3 seconds	→	4000 Ab220A

Example: change number of stitches from 1 to 3 (softstart function (9 key) is already on).

9	Press the 9 key for at least 1 sec. ! The arrow above the key goes off momentarily (softstart function is On)	→	SSc 001
+	Press the + key ! Number of stitches increases.	→	SSc 003
	Display after 3 seconds	→	4000 Ab220A

**This value is saved when you start sewing. It remains in effect even after turning the machine off!
Another possibility is using parameter 401 for immediate storage without having to start sewing.**

5.5.2 Further Functions of the V810/V820 Control Panels

- Press the >> key → The most significant digit blinks.
- Press the +/- key briefly → The blinking digit changes by ±1.
- Keep the +/- pressed down → The blinking digit keeps changing its value, as long as the key is pressed down.
- Press the >> key once more → The next digit blinks.
- Press the +/- key as above!
- Press the **E** key → The setting is completed.

With the code number and parameter number there is no carry over when changing from **0 to 9** or vice versa. Parameter values are, however, carried over. Therefore, you can use the +/- keys to change the value between the minimum and maximum value.

If the value change is significant, it is better to use the >> key. If the value change is insignificant, use the +/- keys.

For setting the minimum or maximum value, select the most significant digit by means of the >> key. Then keep pressing the - key for the minimum or the + key for the maximum value.

The above description is applicable to both control panels, V810 and V820. Direct input of values is possible with the V820 using the **0...9** keys.

5.5.3 Special Functions of the V820 Control Panel

2	0	0	Select parameter 200	→	F-200
E			Press the E key. The set value is displayed.	→	F-200 t1 050
0	0	0	Press the 0 key three times. The minimum value is displayed.	→	F-200 t1 000
9	9	9	Press the 9 key three times. The maximum value is displayed.	→	F-200 t1 500

5.6 Programming of Seams (TEACH IN)

- A maximum of 99 patterns with a total of 99 seams can be programmed, i. e. 1 pattern with 99 seams each or 99 patterns with 1 seam each. In between, all combinations are possible.
- Programming is possible with or without code number.
- The functions “start backtack”, “end backtack”, “stitch counting”, “light barrier”, “thread trimmer”, “sewing foot lift” and “needle positions” can be assigned individually to each seam.
- The functions of signals A1 and A2 can also be assigned to each seam, on condition that slide-in strip 6, 8, 9, 10 has been inserted into the V820 control panel and activated by means of the respective parameter 292.
- The stitches for start and end backtack and stitch counting as well as the compensating stitches for the light barrier function can be programmed individually for each seam section.
- Several counted seam sections can be linked (9 key).

Attention! The “TEACH IN“ function has been changed as compared to the 62 and 82 type series!

Seams and/or patterns can be added by pressing the **INSERT F1** key or erased by pressing the **DELETE F2** key. Before programming new patterns and/or seams it is advisable to erase previously saved patterns and/or seams by pressing the **DELETE F2** key according to chapter “Deleting a Seam or Pattern“. If patterns or seams are to be inserted between existing ones, press the **INSERT F1** key according to chapter “Inserting a Seam or Pattern“.

Example: 3 patterns are in the memory. Delete the 2nd pattern by pressing the **DELETE F2** key. The 3rd pattern takes the place of the 2nd pattern. A new 2nd pattern can be intalled by pressing the **INSERT F1** key. The pattern in 2nd place will go back to being pattern no. 3.

If patterns and/or seams are only to be added, proceed as described in the following chapters.

The figure below shows all the functions assigned to programming of seams **TEACH IN**.

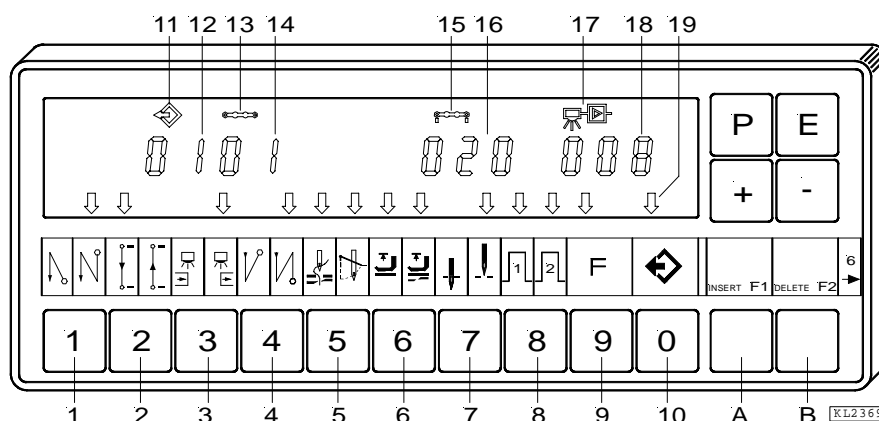

- | | |
|---|--|
| <p>1 = Single start backtack On (lefthand arrow)
Double start backtack On (righthand arrow)
Start backtack Off</p> <p>2 = Counted seam forward On (lefthand arrow)
Counted seam backward On (righthand arrow)
Counted seam Off</p> <p>3 = Light barrier uncovered/covered On (lefthand arrow)
Light barrier covered/uncovered On (righthand arrow)
Light barrier Off</p> <p>4 = Single end backtack On (lefthand arrow)
Double end backtack On (righthand arrow)
End backtack Off</p> <p>5 = Thread trimmer On (lefthand arrow)
Thread wiper On (righthand arrow)
Thread trimmer and thread wiper On (both arrows)
Thread trimmer and thread wiper Off</p> <p>6 = Sewing foot in the seam On (lefthand arrow)
Sewing foot after seam end On (righthand arrow)
Sewing foot in the seam and after seam end On (both arrows)
Sewing foot Off</p> <p>7 = Basic position down (lefthand arrow)
Basic position up (righthand arrow)</p> | <p>8 = Signal A1 On (lefthand arrow)
Signal A2 On (righthand arrow)
Signal A1 and A2 On (both arrows)
Signal A1 and A2 Off</p> <p>9 = Switching from one seam to the next On (lefthand arrow)
Switching from one seam to the next Off</p> <p>10 = Programmed seams TEACH IN On (lefthand arrow)
Programmed seams TEACH IN Off</p> <p>11 = Program symbol</p> <p>12 = Display of program number</p> <p>13 = Seam symbol</p> <p>14 = Display of seam number</p> <p>15 = Symbol for number of stitches of a seam</p> <p>16 = Display of number of stitches</p> <p>17 = Light barrier symbol</p> <p>18 = Display of light barrier compensating stitches</p> <p>19 = Arrow for TEACH IN</p> <p>A = INSERT → Insert seams or patterns</p> <p>B = DELETE → Delete seams or patterns</p> |
|---|--|

5.6.1 Programming after Code Number Input

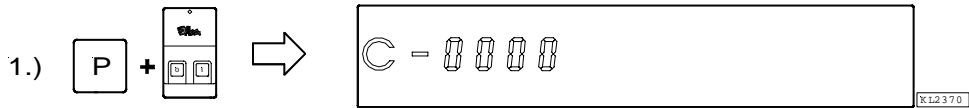

- Input code number by means of the 0...9 means.

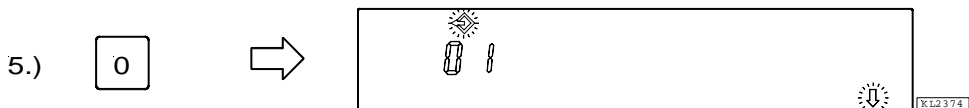
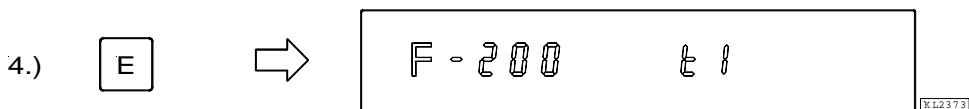
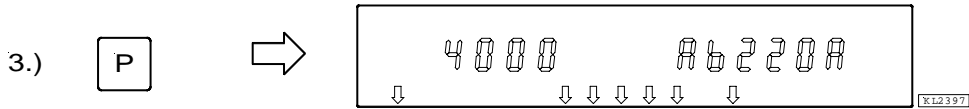
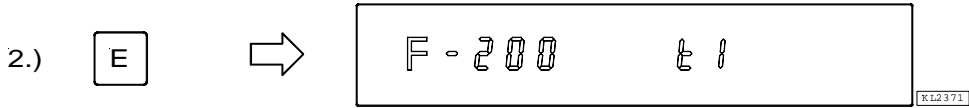

- Activate programming of seams TEACH IN by means of the 0 key / Display of pattern number. Select the next pattern number by means of the + key, in case the actual pattern is already programmed.

Continue the programming of seams as described in the next chapter “Programming without Code Number Input” from item 4.) onwards.

5.6.2 Programming without Code Number Input

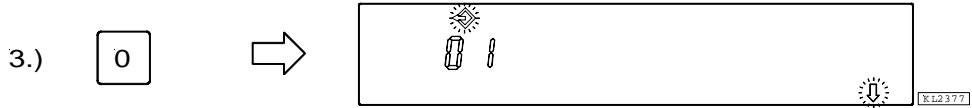
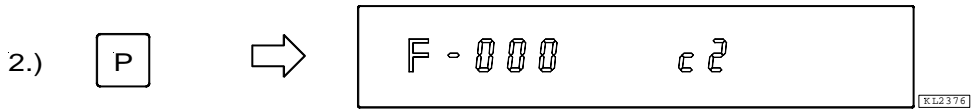
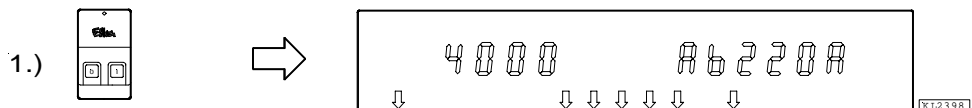

- Activate programming of seams TEACH IN by means of the 0 key / Display of pattern number. Select the next pattern number by means of the + key, in case the actual pattern is already programmed.

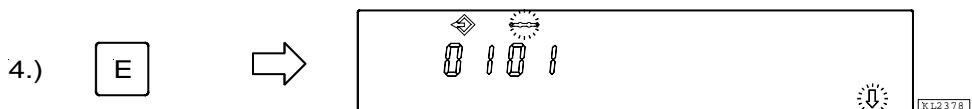

- Display of seam number

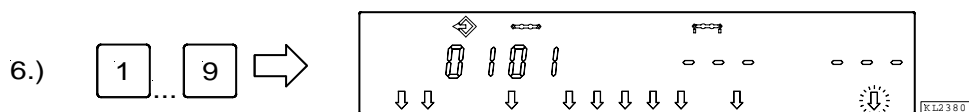
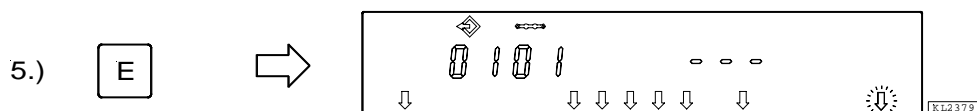

- Enable all desired functions of the actual seam. as for ex. light barrier, by pressing the **1...9** keys.

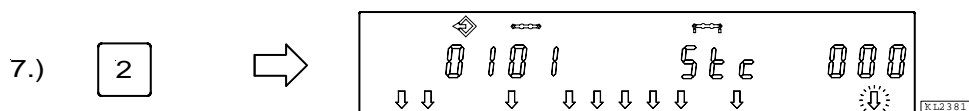

- After having enabled stitch counting by means of the **2** key, the number of stitches can be varied within 2 seconds. If stitch counting has already been selected, press the **2** key for approx. 2 seconds in order to vary the number of stitches. The arrow above the **2** key switches briefly.

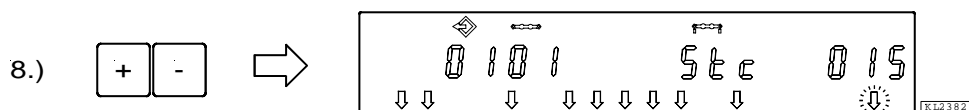

- Press the + / - key immediately.

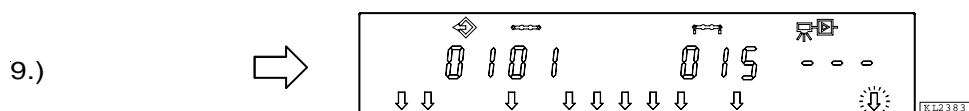

- If the + / - key has not been pressed within 2 seconds, the previously input number of stitches will be displayed under the corresponding symbol (normal display).

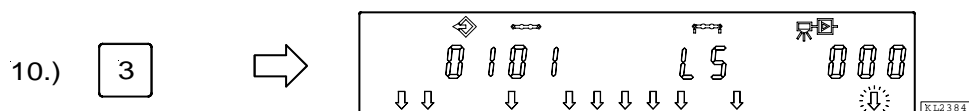

- After having enabled the light barrier by means of the **3** key, the number of light barrier compensating stitches can be varied within 2 seconds. If the light barrier has already been selected, press the **3** key for approx. 2 seconds in order to vary the number of light barrier compensating stitches. The arrow above the **3** key switches briefly.

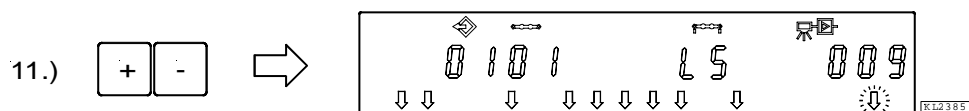

- Press the + / - key immediately.

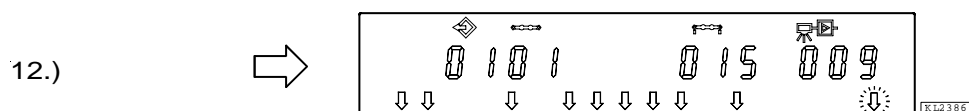

- If the + / - key has not been pressed within 2 seconds, the previously input number of stitches will be displayed under the corresponding symbol (normal display).
- Change to the next seam by pressing the **E** key once.
- Exit programming of seams by pressing the **P** key twice.
- **Start sewing** in order to save the values.

5.6.3 Detailed Example

A seam 01 with double start backtack, stitch counting forward, position down, sewing foot up, a seam 02 with stitch counting forward, position down and a seam 03 with light barrier, double end backtack, thread trimming, position up, sewing foot up, are to be programmed (without code number input) under the next possible pattern number, e.g. 01.

- Turn power on
- Press the **P** key → Parameter 000 is displayed.
- Press the **0** key → Pattern number is displayed. The pattern symbol and the lefthand arrow above the 0 key blink.
- Press the **F2** key → Existing patterns will be deleted. If there is a 2nd pattern or more patterns, pattern number 01 must be inserted by pressing the INSERT F1 key.

Set functions of seam 01:

- Press the **E** key → Seam number **01** is displayed.
- Press the **E** key → Functions can be programmed.
- Press the **1** key → The righthand arrow above the 1 key indicates that the double start backtack is On. The start backtack stitches must be input individually.
- Press the **2** key → The lefthand arrow above the 2 key indicates that stitch counting forward is On. The number of stitches can be varied as previously shown.
- Press the **6** key → The lefthand arrow above the 6 key indicates that the sewing foot is automatically lifted in the seam.
- Press the **7** key → The lefthand arrow above the 7 key indicates that the needle is in the down position.

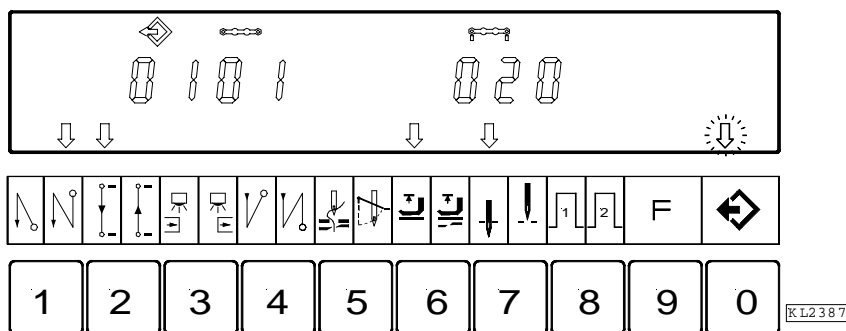

Display of seam **01** after correct function input

Set functions of seam 02:

- Press the **E** key → Seam number **02** is displayed.
- Press the **2** key → The lefthand arrow above the 2 key indicates that stitch counting forward is On. The number of stitches can be varied as previously shown.
- Press the **7** key → The lefthand arrow above the 7 key indicates that the needle is in the down position.

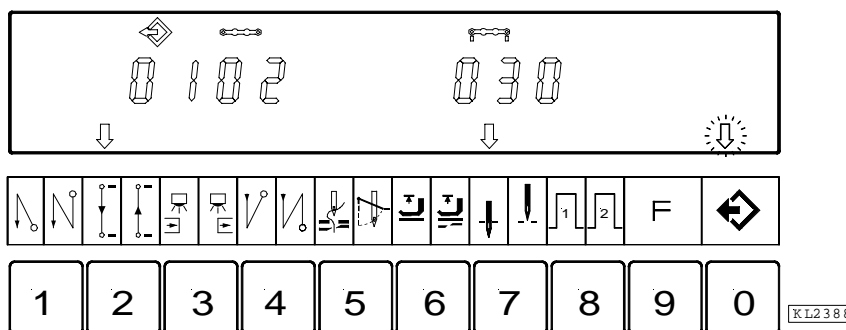

Display of seam **02** after correct function input

5.6.5 Deleting a Seam or Pattern

A pattern or seam can be deleted by means of the B “DELETE F2” key, on condition that the symbol above the pattern or seam number is blinking during programming.

- Select the pattern or seam number to be deleted. The symbol above the pattern or seam number must be blinking. Proceed as shown in chapters “Programming with or without Code Number Input”.
- Press the B “DELETE F2” key twice in brief succession. The pattern or seam number will be deleted. All subsequent numbers are automatically reduced by “1”. The following example shows how seam number 2 is deleted.

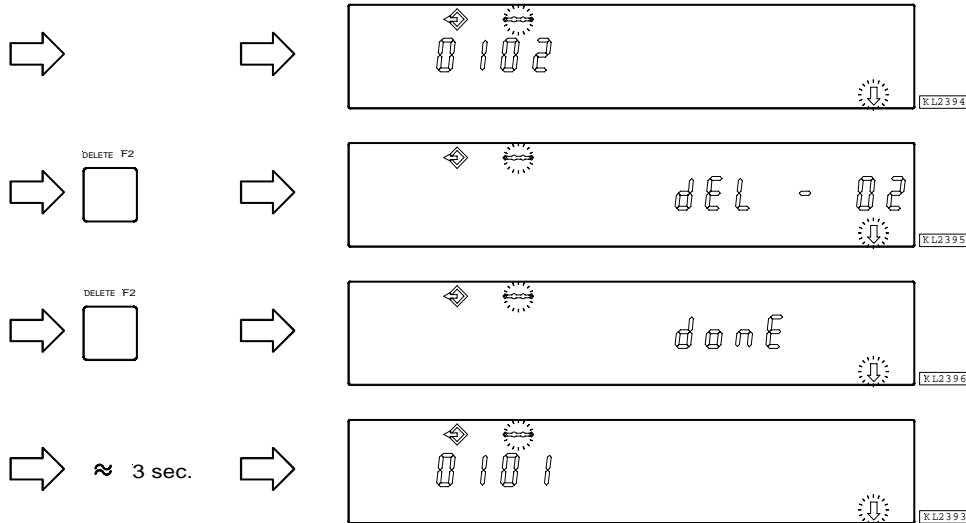

5.6.6 Execution (Pattern) Mode

- Press the 0 key → The programmed seams are enabled. Arrow above the 0 key is On (but it does not blink).
- Press the +/- key → Selection of pattern. Only if several patterns have been programmed.
- Press the E key → If you do not wish to start with the first seam, select a different seam number. Press the E key several times until the desired seam number is displayed.
- The drive can now be started by pressing the pedal, and the pattern can be executed.
- Press the 0 key → The programmed seams are disabled. Arrow above the 0 key is Off.

5.6.7 Further Settings for TEACH IN

Functions	Parameter
Seam suppression if 0 stitches are set (Std)	321

Parameter 321 = 0 Seam suppression disabled: i. e. if the light barrier is Off and stitch counting is set at 0 stitches, a free seam will be performed.

Parameter 321 = 1 Seam suppression enabled: i. e. if the light barrier is Off and stitch counting is set at 0 stitches, the program switches to the next seam if the function is On. In case functions such as start of end backtack, thread trimmer, signals A1 / A2 are On, they will be performed before switching to the next seam.

Functions	Parameter
Correction seam On/Off, seam or pattern interruption by thread trimmer (dkn)	322

Parameter 322 = 0 Correction seam disabled: The seam can be interrupted by pressing the pedal to pos. -2. The control switches automatically to the next seam number.

Parameter 322 = 1 Correction seam enabled

- The seam can be interrupted by pressing the pedal to pos. -2 and thread trimming, and a correction seam (free seam) can be performed manually.
- The correction seam can be completed by pressing the pedal to pos. -2 or by light barrier if it is On. Then the control switches automatically to the next seam number.

Parameter 322 = 2 Seam or pattern interruption by thread trimming

- The seam can be interrupted by pressing the pedal to pos. -2 and thread trimming, even if the thread trimmer is Off. Then the program switches back to the **first** seam of the selected pattern.

Sewing foot lift functions if TEACH IN is On:

After power on the sewing foot is down even if sewing foot lifting after thread trimming is On on the control panel. the sewing foot can be lifted by pressing the pedal to pos. -1 or -2.

If sewing foot lifting is On at the seam end (righthand arrow above the 6 key on the V820 control panel On), the sewing foot is lifted after completing the seam. After having pressed the pedal to pos. 0 (neutral) the control switches to the next seam, and the sewing foot remains lifted until sewing is started. Whether or not the sewing foot is On or Off does not influence the seam end in the new seam.

Automatic sewing foot lift with pedal forward at the seam end, if light barrier or stitch counting is On:

Parameter 023 = 0 Automatic sewing foot lift Off

Parameter 023 = 1 Automatic sewing foot lift On

Parameter 023	6 key (righthand arrow)	Sewing foot with pedal forward after the seam end	Sewing foot with pedal = 0
0	0	Off	Off
1	0	On	Off
1	1	On	On
0	1	On	On

Functions	Parameter
Sewing foot lifted after power On, or as programmed (FLn)	323

This function is active only if TEACH IN is On.

Parameter 323 = 0 After power On, the sewing foot lift function works as programmed.

Parameter 323 = 1 The sewing foot is always lifted after power On, even if automatic sewing foot lift is not programmed.

Functions	Parameter
TEACH IN On/Off (ti)	324

Using this parameter, TEACH IN can be enabled and disabled without control panel. However, TEACH IN programming is possible only with the V820 control panel.

When the V820 is connected, TEACH IN is enabled and disabled by means of the 0 key.

Functions	Parameter
Erasing all TEACH IN data (cti)	325

- Input code number 3112 after power On → Press the **E** key
- Input parameter 325 → Press the **E** key
- Input 3112 → Press the **P** key
- The display briefly shows “**deleted**“, and a short audible signal is issued. → Press the **P** key
- All TEACH IN programs have been erased! → Press the **P** key
- The sewing process is enabled again.
- If you press the **0** key now, the display shows “**no ProG**“

6 Putting into Service

Before putting the control into service, the following must be ensured, checked and/or adjusted:

- The correct installation of the drive, position transmitter and accompanying devices, if necessary
- The correct selection of the trimming operation by means of parameter 290
- If necessary, the correct adjustment of the direction of motor rotation by means of parameter 161
- The correct selection of the functions of keys (inputs) by means of parameters 240...249
- The setting of the transmission ratio between motor shaft and machine shaft by means of parameter 272
- The setting of the type of position sensor by means of parameter 270
- If necessary, the setting of the number of angular degrees after the sensor position by means of parameter 271
- If necessary, the setting of the positions by means of parameter 171 (possible with all settings of parameter 270)
- The correct positioning speed by means of parameter 110
- The correct maximum speed compatible with the sewing machine by means of parameter 111
- The setting of the remaining relevant parameters
- Start sewing in order to save the set values

7 Setting and Putting into Service with the Aid of the Fast Installation Routine (SIR)

The Fast Installation Routine (SIR) passes through all parameters necessary for programming the functional sequence and the positions.

Input parameter 500



Parameter for functional sequence
“thread trimming operations”



Parameter for direction of motor rotation



Parameter for transmission ratio
Important! The transmission ratio should be determined and indicated as precisely as possible.



Parameter for type of position sensor



Parameter for position 1



Parameter for position 2

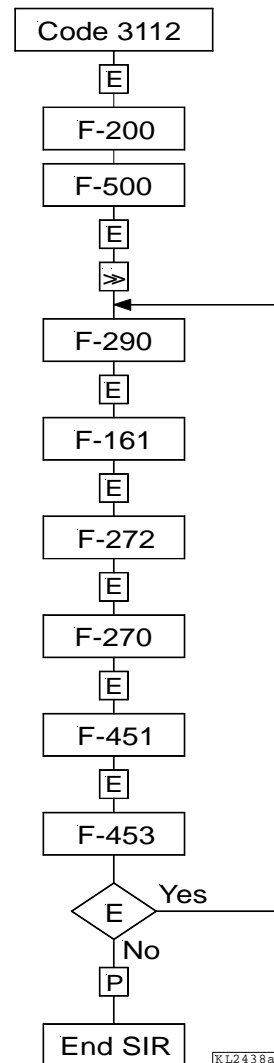

The values can be varied by pressing the +/- keys. When the parameter is displayed on the V810 control panel, press the E key once more for the value to be displayed.

With SIR you can do the most important settings for initial operation with menu prompting. For safety reasons, the menu must be executed point by point. This ensures correct setting of all important parameters. The setting of other parameters is not affected.

Functions	Parameter
Call-up of the Fast Installation Routine SIR	(Sir) 500

Setting on the V810 control panel:

- Input code number **3112!**
- Press the **E** key → The lowest parameter **2.0.0.** appears at this level
- Select **500** → Parameter **5.0.0.** is displayed
- Press the **E** key → Character **[o]** appears blinking
- Press the **>>** key → Parameter **2.9.0.** appears (functional sequence “trimming operations”)
- Press the **E** key → Parameter value **05** appears
- Press the **+/-** key → Parameter value can be changed
- Press the **E** key → Parameter **1.6.1.** appears (direction of motor rotation)
- Press the **E** key → Parameter value **1** appears
- Press the **+/-** key → Parameter value can be changed
- Press the **E** key → Parameter **2.7.2.** appears (transmission ratio)
- Press the **E** key → Parameter value **100** appears
- Press the **+/-** key → Parameter value can be changed
- Press the **E** key → Parameter **2.7.0.** appears (type of position sensor)
- Press the **E** key → Parameter value **0** appears
- Press the **+/-** key → Parameter value can be changed
- Press the **E** key → Parameter **4.5.1.** appears (position 1 leading edge; position 1 trailing edge is automatically set at 60°)
- Press the **E** key → Parameter value appears
- Press the **+/-** key → Parameter value can be changed
- Or turn handwheel → Min. 1 rotation, then set position.
- Press the **E** key → Parameter **4.5.3.** appears (position 2 leading edge; position 2 trailing edge is automatically set at 60°)
- Press the **E** key → Parameter value appears
- Press the **+/-** key → Parameter value can be changed
- Or turn handwheel → Min. 1 rotation, then set position.
- Upon pressing the **E** key once more the program returns to parameter 290
- Press the **P** key twice → Exit SIR routine

Setting on the V820 control panel:

- Input code number **3112!**
- Press the **E** key → The lowest parameter **2.0.0.** appears at this level
- Select **500** → Parameter **5.0.0.** is displayed
- Press the **E** key → Character **[o]** appears blinking
- Press the **>>** key → Parameter **290 FAm 05** appears (functional sequence “trimming operations”)
- Press the **+/-** key → Parameter value can be changed
- Press the **E** key → Parameter **161 drE 1.** appears (direction of motor rotation)
- Press the **+/-** key → Parameter value can be changed
- Press the **E** key → Parameter **272 trr 100** appears (transmission ratio)
- Press the **+/-** key → Parameter value can be changed
- Press the **E** key → Parameter **270 PGM 0** appears (type of position sensor)
- Press the **+/-** key → Parameter value can be changed
- Press the **E** key → Parameter **451** appears (position 1 leading edge; position 1 trailing edge is automatically set at 60°)
- Press the **+/-** key → Parameter value can be changed
- Or turn handwheel → Min. 1 rotation, then set position.
- Press the **E** key → Parameter **453** appears (position 2 leading edge; position 2 trailing edge is automatically set at 60°)
- Press the **+/-** key → Parameter value can be changed
- Or turn handwheel → Min. 1 rotation, then set position.
- Upon pressing the **E** key once more the program returns to parameter 290
- Press the **P** key twice → Exit SIR routine

8 Setting the Basic Functions

8.1 Direction of Motor Rotation

Function with or without control panel	Parameter
Direction of motor rotation (drE)	161

Parameter 161 = 0 Clockwise motor rotation (look at the motor shaft)
Parameter 161 = 1 Counterclockwise motor rotation



ATTENTION

If the motor is mounted differently, e. g. at a different angle or with gear, make sure that the value set by means of parameter 161 corresponds to the direction of rotation.

8.2 Transmission Ratio

Note

The transmission ratio must always be input, because only motors with integrated incremental transmitter will be used.
The transmission ratio should be determined and set as precisely as possible!

The transmission ratio between motor shaft and shaft of the sewing machine head must be input, so that the set speeds of parameters 110...117 correspond to the sewing speeds.

Function with or without control panel	Parameter
Transmission ratio between motor shaft and machine shaft (trr)	272

The transmission ratio can be selected within a range of 020...255 using parameter 272.

Example: With a motor pulley diameter of 40mm and a sewing machine head pulley diameter of 80mm the value 50 can be calculated using the formula below. If the value 200 has been selected in parameter 272, it follows that the motor pulley is double the size of the sewing machine head pulley.

$$\text{Value of parameter 272} = \frac{\text{Motor pulley diameter}}{\text{Machine pulley diameter}} \times 100$$

8.3 Selection of Functional Sequences (Thread Trimming Operations)

Lockstitch, chainstitch and overlock machines with different functional sequences can be operated using this control. The functional sequences can be selected by means of parameter 290.



ATTENTION

Before switching functional sequences, detach cables from the inputs and outputs! Please ensure that the machine installed provides the functional sequence to be set!
Settings with parameter 290 only after power On!

Setting the functional sequence using parameter 290										
Mode	Designation	Adapter	Outputs							
	Power transistors →		FL ST2/35	VR ST2/34	M1 ST2/37	M2 ST2/28	M3 ST2/27	M4 ST2/36	M5 ST2/32	M6 ST2/30
0	Lockstitch; e. g. Brother (737-113, 737-913) Aisin (AD3XX, AD158, 3310; EK1) Pfaff (563, 953, 1050, 1180) Dürkopp Adler (210, 270)	Functions 1112814 1112815 1112841 1112845	FL FL FL FL	VR VR VR VR	FA1 FA1 + FA1 FA1 +	FA2 FA2 FA2 FA2	FW FW FW FW	FA1+2	ML ML	MST
2	Lockstitch; e. g. Singer (212 UTT)	Functions 1112824	FL FL	VR VR	FA FA	FA FA	FSPL FSPL	FL1 FL1	ML	MST
3	Lockstitch; e. g. Dürkopp Adler (467)		FL	VR	FA	FSPL	FW		ML	MST
4	Chainstitch; e. g. Union Special (34000 and 36200 replacement for US80A) (CS100 and FS100)	Functions 1112865 1112905	FL FL	FA-R FA-R	M1 M1	FA-V FA-V	FW FW	STV	ML ML ML	
5	Chainstitch; parallel sequence Bag sewing machine Union Special	Functions Functions	FL FL	STV STV	M1 FA	M2 IMP	M3 BR	M4	ML ML	MST MST
	Yamato (VC series) Yamato (VG series) Kansai (RX 9803) Pegasus (W500/UT, W600/UT/MS with or without stitch condensing)	1112818 1113178 1113130 1112821	FL FL FL	STV STV STV	FA FA FA	FA FA	FW FW FW		ML ML	
	Brother (FD3-B257) Union Special (34700) Global (CB2803-56) Rimoldi (F27)	1112822 1112844 1112866 1113096	FL FL FL FL	STV STV	FA FA	FA FA	FW FW FA FAU		NK	
6	Chainstitch; tape cutter/fast scissors		FL	STV	FW M1	FAO M2	FAU AH1	AH2	ML ML	MST
7	Overlock		FL	KS	M1	M2	AH	FSPL	ML	MST
8	Backlatch Pegasus	Functions 1113234	FL		PD≤-1 PD≤-1	PD≥1 PD≥1	PD≥1* PD≥1*		ML	MST
9	Backlatch Yamato (ABT3) Yamato (ABT13, ABT17)	Functions 1112826 1113205	FL		PD≤-1 PD≤-1	PD≥1 PD≥1	PD≥1* PD≥1*		ML	MST
10	Lockstitch; e. g. Union Special (63900AMZ replacement for US80A) and on Refrey lockstitch machines	Functions 1112823	FL FL	FA-R FA-R	FSPL	FA-V FA-V	FW FW	VR	ML ML	MST
14	Lockstitch; e. g. Juki (5550-6) Juki (5550-7) (position sensor incorporated in the handwheel)	Functions 1112816 1113132 + 1113157	FL FL FL	VR VR VR	FA1+2 FA1+2 FA1+2	FA2 FZ	FW FW FW	FA1	ML	MST
15	Backlatch Pegasus (SSC100)		FL	KS/KB	KB	KS	FSPL	AH	ML	HP
16	Overlock; feed-off-the-arm machine e.g. Yamato (FD62)		FL	KS	RB	M2	AH	FSPL	ML	MST
17	Chainstitch; Pegasus		FL	LFA		FA	STS		ML	
20	Lockstitch; Juki (LU1510-7)	1113200	FL	VR	FA	FSPL			ML	MST
21	Chainstitch; Yamato (stitch lock)	1113178	FL	STS	FA	STV	FW		ML	
23	Lockstitch; Dürkopp Adler (271...275)		FL	VR	FA	ML	FW	FSPL	HP	MST
24	Chainstitch; Pegasus (MHG-100)	1113267	FL		FA	FA	FW			

*) The signal issued at this output is inverted!

See the following page for letter symbols of the solenoid outputs!

Explanation of letter symbols of the previous page

Outputs:

FL	= Sewing foot lifting	FL1	= Sewing foot lifting without pulsing
VR	= Backtacking	STV	= Stitch condensing
FA	= Thread trimmer	FA1	= Thread trimmer pos. 1...1A
FA2	= Thread trimmer pos. 1A...2	FA1+2	= Thread trimmer pos. 1...2
FA-V	= Thread trimmer forward	FA-R	= Thread trimmer backward
FAU	= Bobbin thread trimmer	FAO	= Needle thread trimmer
FSPL	= Thread tension release	AH	= Tape cutter
FW	= Thread wiper	AH1/AH2	= Fast scissors
ML/NK	= Machine running / Needle cooling	KS	= Chain suction
RB	= Chain blowing in opposite direction	STB	= Blow fabric onto stack
KB	= Chain blowing	KS+KB	= Chain suction + blowing
MST	= Machine at standstill	HP/FF1	= High lift for walking foot / flip-flop 1
PD≥1	= Pedal steps 1...12	PD≤-1	= Pedal steps -1 / -2
PD=0	= Pedal step 0	PD-2	= Pedal step -2
L-STL	= Indicator lamp for stitch length	DR-UK	= Reversal of motor direction
FZ	= Thread puller	STS	= Stitch lock
IMP	= Impulse	BR	= Hot thread chain cutting
LFA	= Top cover thread cutter		

Mode 0 Lockstitch Machines

- Thread trimmer from leading to trailing edge of slot position 1
- Thread trimmer from trailing edge of slot position 1 to leading edge of slot position 2
- Thread trimmer from leading edge of slot position 1 to leading edge of slot position 2
- Thread wiper for a programmable time (t6)
- Sewing foot lifting (see chapter "Sewing Foot Lifting")
- Backtacking (see chapter "Start Backtack" and "End Backtack")
- Signal "machine running"
- High lift for walking foot/flip-flop at limited speed after pressing the key

Mode 2 Lockstitch Machines (Singer 212 UTT)

- Thread trimmer for a programmable time (kt2) after intermediate stop in position 1
- Thread trimmer from leading edge of slot position 1 to leading edge of slot position 2
- Sewing foot lifting (see chapter "Sewing Foot Lifting")
- Backtacking (see chapter "Start Backtack" and "End Backtack")
- Signal "machine running"
- High lift for walking foot/flip-flop at limited speed after pressing the key

Mode 3 Lockstitch Machines with Thread Trimming System (e. g. Dürkopp Adler)

- Thread trimmer for programmable increments (iFA) after intermediate stop in position 1
- Thread tension release from trailing edge of slot position 2 after delay (FSE) during ON period (FSA)
- Thread wiper for a programmable time (t6)
- Sewing foot lifting (see chapter "Sewing Foot Lifting")
- Backtacking (see chapter "Start Backtack" and "End Backtack")
- Signal "machine running"
- High lift for walking foot/flip-flop at limited speed after pressing the key

Mode 4 Chainstitch Machines (Union Special)

- Thread trimmer forward after stop in position 2 after delay (kd2) during ON period (kt2)
- Thread trimmer backward after stop in position 2 after delay (kd1) during ON period (kt1)
- Thread wiper after stop in position 2 after delay (kd3) during ON period (kt3)
- Sewing foot lifting (see chapter "Sewing Foot Lifting")
- Stitch condensing (see chapter "Start Stitch Condensing" and "End Stitch Condensing")
- Signal "machine running"

Mode 5 Chainstitch Machines In General

- Signal M1 after stop in position 2 after delay (kd1) during ON period (kt1)
- Signal M2 after stop in position 2 after delay (kd2) during ON period (kt2)
- Signal M3 after stop in position 2 after delay (kd3) during ON period (kt3)
- Signal M4 after stop in position 2 after delay (kd4) during ON period (kt4)
- Time-delayed (kdF) sewing foot lifting after standstill in position 2 (see chapter "Sewing Foot Lifting")
- Stitch condensing (see chapter "Start Stitch Condensing" and "End Stitch Condensing")
- Signal "machine running"
- Signal "machine at standstill"

- Mode 6** Chainstitch Machines with Tape Cutter or Fast Scissors
- Signal M1 after stop in position 2 after delay (kd1) during ON period (kt1)
 - Signal M2 after stop in position 2 after delay (kd2) during ON period (kt2)
 - Fast scissors (M3) after delay (kd3) during ON period (kt3) alternating with M4
 - Fast scissors (M4) after delay (kd4) during ON period (kt4) alternating with M3
 - Sewing foot lifting (see chapter "Sewing Foot Lifting")
 - Stitch condensing (see chapter "Start Stitch Condensing" and "End Stitch Condensing")
 - Signal "machine running"
 - Signal "machine at standstill"
- Mode 7** Overlock Machines
- Signal M1 after stop in position 2 after delay (kd1) during ON period (kt1)
 - Signal M2 after stop in position 2 after delay (kd2) during ON period (kt2) or if parameter 232=1, as **fast scissors** alternating with M3 (**parameter 282=0**)
 - Chain suction during stitch count (c1) at the start of the seam and stitch counting (c2) at the seam end
 - Thread tension release after light barrier uncovered
 - Tape cutter at the start of the seam after stitch count (c3) and at the seam end after stitch count (c4) and the delay time (kd3)
 - Sewing foot lifting (see chapter "Sewing Foot Lifting")
 - If parameter 018 = 1, parameter 022 must also be set at "1"
 - Signal "machine running"
 - Signal "machine at standstill"
- Mode 8** Backlatch Machines (Pegasus)
- Signal M1 with pedal in positions -1 and -2
 - Signal M2 with pedal in positions 1-12
 - Inverted signal M3 with pedal in positions 1-12
 - Sewing foot lifting (see chapter "Sewing Foot Lifting")
 - Signal "machine running"
 - Signal "machine at standstill"
 - Operation at automatic speed
 - Automatic speed has priority over machine run blockage
 - Machine run blockage effective with open contact (**input in1 / parameter 240=6**)
»Automatic speed has priority over machine run blockage«
 - Key for operation at automatic speed (**input in3 / parameter 242=10**)
- Mode 9** Backlatch Machines (Yamato)
- Signal M1 with pedal in positions -1 and -2
 - Signal M2 with pedal in positions 1-12
 - Inverted signal M3 with pedal in positions 1-12
 - Sewing foot lifting (see chapter "Sewing Foot Lifting")
 - Signal "machine running"
 - Signal "machine at standstill"
 - Key for operation at automatic speed (**input in3 / parameter 242=10**)
 - Machine run blockage effective with open contact (**input in1 / parameter 240=6**)
 - Machine run blockage has priority over automatic speed
- Mode 10** Lockstitch Machines (Refrey Trimmer)
- Thread trimmer from trailing edge of slot position 1 to leading edge of slot position 2
 - Thread trimmer backward after stop in position 2 during ON period (kt1).
 - After that the signal is pulsed.
 - Thread tension release whose signal is parallel to the thread trimmer
 - Thread wiper (M3) after delay (kd3) during ON period (kt3)
 - Sewing foot lifting (see chapter "Sewing Foot Lifting")
 - Backtacking (see chapter "Start Backtack" and "End Backtack")
 - Signal "machine running"
- Mode 14** Lockstitch Machines (Juki 5550-6, 5550-7)
- Thread trimmer (M1) from trailing edge of slot position 1 to leading edge of slot position 2
 - Thread trimmer (M4) from leading edge of slot position 1 to leading edge of slot position 2
 - Thread wiper (M3) for a programmable time (t6)
 - Thread puller (M2) after stop in position 2 after delay (kd2) during ON period (kt2)
 - Sewing foot lifting (see chapter "Sewing Foot Lifting")
 - Backtacking (see chapter "Start Backtack" and "End Backtack")
 - Signal (M5) "machine running"
 - Signal (M6) "machine at standstill"
 - Positioning by Juki handwheel sensor on the control

Mode 15 Backlatch Machines (Pegasus SSC100)

- Chain blowing (M1) during stitch count (c4) at the start of the seam and during ON period (kt1) at the seam end after tape cutting
- Chain suction (M2) during stitch count (c3) at the start of the seam and during ON period (kt1) at the seam end after tape cutting
- Thread tension release (M3) On after stitch count (c1) and Off after light barrier uncovered and stitch count (c2)
- 1st tape cutting (M4) after light barrier uncovered and stitch counting (ckL) during ON period (kt4), 2nd tape cutting after delay (kd4) during ON period (kt4)
- Chain suction + blowing (VR) On at the end of the 1st tape cutting after delay (kd2) and Off after the start of the 2nd tape cutting with a time lapse (kt2)
- Sewing foot lifting (see chapter "Sewing Foot Lifting")
- Signal "machine running"
- High lift for walking foot operational mode stored (**input in4 / parameter 243=14**)
- Manual tape cutting (**input in5 / parameter 244=15**)

Mode 16 Overlock Machines (Feed-Off-The-Arm Machines) only with V820 and slide-in strip 7!

- Chain suction (VR) during stitch count (c1) at the start of the seam
- Thread tension release (M4) On at the seam end after light barrier uncovered and the compensating stitches until pedal position 0 (neutral) after machine standstill
- Tape cutter (M3) if parameter 232=0 at the start of the seam after stitch count (c3) and at the seam end after stitch count (c4) during ON period (kt3)
- Fast scissors if parameter 232=1 at the start of the seam after stitch count (c3) and at the seam end after stitch count (c4) alternating with output (M3) during ON period (kt3) and output (M8) during ON period (At1)
- Chain blowing in opposite direction (M1) at the seam end after delay (kd1) during ON period (kt1)
- Blow fabric onto stack (M7) On at the seam end after light barrier uncovered until machine standstill with a time lapse (kt5)
- Signal (M2) at the seam end after delay (kd2) during ON period (kt2)
- Sewing foot lifting with pedal in position -1 or -2
- Signal "machine running"

Mode 17 Chainstitch Machines (Pegasus Stitch Lock)

- Thread trimmer (FA) after stop depending on angle after delay (kd2) during ON period (kt2)
- Stitch lock signal (STS) after intermediate stop in position 2 after delay (kd3) during ON period (kt3) and after stop depending on angle
- Top cover thread cutter (LFA) after stop depending on angle and delay (kd2) during ON period (kt2)
- Time-delayed (kdF) sewing foot lifting after standstill in position 2 (see chapter "Sewing Foot Lifting")
- Signal "machine running"

Mode 20 Lockstitch Machines (Juki LU1510-7)

- Thread trimmer (FA) for programmable increments (iFA) after intermediate stop in position 1
- Thread tension release from trailing edge of slot position 2 after delay (FSE) during ON period (FSA)
- Thread wiper after stop in position 2 after delay (kd3) during ON period (kt3)
- Sewing foot lifting (see chapter "Sewing Foot Lifting")
- Backtacking (see chapter "Start Backtack" and "End Backtack")
- Signal (M5) "machine running" / Signal (M6) "machine at standstill"

Mode 21 Chainstitch Machines (Yamato Stitch Lock)

- Thread trimmer (M1) after stop in position 2 after delay (kd1) during ON period (kt1)
- Thread wiper (M3) after stop in position 2 after delay (kd3) during ON period (kt3)
- Stitch lock signal (STV) after stop in position 1 after delay (kd2) during ON period (kt2)
- Time-delayed (kdF) sewing foot lifting after standstill in position 2 (see chapter "Sewing Foot Lifting")
- Stitch condensing (M2) (see chapter "Start Stitch Condensing" and "End Stitch Condensing")
- Signal (M5) "machine running"

Mode 23 Lockstitch Machines (Dürkopp Adler 271...275)

- Thread trimmer (M1) for programmable increments (iFA) after intermediate stop in position 1
- Thread tension release (M4) from trailing edge of slot position 2 after delay (FSE) during ON period (FSA)
- Thread wiper (M3) for a programmable time (t6)
- Sewing foot lifting (see chapter "Sewing Foot Lifting")
- Backtacking (see chapter "Start Backtack" and "End Backtack")
- Signal (M2) "machine running"
- High lift for walking foot/flip-flop (M5) at limited speed after pressing the key

Mode 24 Chainstitch Machine (Pegasus MHG-100)

- Thread trimmer (M1) after stop in position 2 after delay (kd2) during ON period (kt2)
- Thread trimmer (M2) after stop in position 2 after delay (kd1) during ON period (kt1)
- Thread wiper (M3) after stop in position 2 after delay (kd3) during ON period (kt3)
- Sewing foot lifting (see chapter "Sewing Foot Lifting")
- Signal (M7) "hemming guide"
- Signal (M8) "hemming blow 1"
- Signal (M9) "hemming blow 2"

See List of Parameters chapter "Timing Diagrams" for the various modes!

8.4 Functions of the Keys Inputs in1...i10

Function with or without control panel				Parameter
Input 1	selectable input functions	0...47	(in1)	240
Input 2	" "	0...47	(in2)	241
Input 3	" "	0...47	(in3)	242
Input 4	" "	0...47	(in4)	243
Input 5	" "	0...47	(in5)	244
Input 6	" "	0...47	(in6)	245
Input 7	" "	0...47	(in7)	246
Input 8	" "	0...47	(in8)	247
Input 9	" "	0...47	(in9)	248
Input 10	" "	0...47	(i10)	249

See List of Parameters for possible input functions of the keys.

8.5 Positioning Speed

Function with or without control panel		Parameter
Positioning speed	(n1)	110

The positioning speed can be set by means of parameter 110 on the control within a range of 70...390 RPM.

8.6 Maximum Speed Compatible with the Sewing Machine

The maximum speed of the machine is determined by the selected pulley and by the following settings:

- Set the maximum speed using parameter 111 (n2)
- Set the maximum speed limitation to the specific level according to the application as described in chapter "Direct Input of Maximum Speed Limitation (DED)".

8.7 Maximum Speed

Function with or without control panel		Parameter
Maximum speed	(n2)	111

Note

See instruction manual of the sewing machine manufacturer for the maximum speed of the sewing machine.

Note

Select the pulley such that the motor runs at approx. 4000 RPM with max. number of stitches.

When programming 3-digit or 4-digit parameter values on the control (without control panel), the 2-digit or 3-digit values displayed must be multiplied by 10.

8.8 Positions

Function with or without control panel		Parameter
Selection according to position sensor	(PGm)	270
Number of angular degrees from the sensor position to position 2	(PGr)	271
Transmission ratio between motor shaft and machine shaft	(trr)	272

After setting parameter 270 at “1, 2, 3 or 4“ an angular degree must be selected by means of parameter 271, which determines the stop in position 2 or 1 after the sensor position. The transmission ratio must already have been input by means of parameter 272.

Connection of a sensor e. g. light barrier to socket B18/7. The following settings are possible using parameter 270:

- Parameter 270 = 0** - The positions can be generated with the help of the transmitter incorporated in the motor and can be set by means of parameter 171.
- Parameter 270 = 1** - Setting the sensor to position 2.
 - Position 1 is set according to the angular degree setting by means of parameter 271.
 - Start measuring from leading edge position 2.
 - 0V at input B18/7 (inside of the window)
 - +5V at input B18/7 (outside of the window)
- Parameter 270 = 2** - Setting the sensor to position 2.
 - Position 1 is set according to the angular degree setting by means of parameter 271.
 - Start measuring from trailing edge position 2.
 - Input and output level as with setting “1“
- Parameter 270 = 3** - Setting the sensor to position 1.
 - Position 2 is set according to the angular degree setting by means of parameter 271.
 - Start measuring from leading edge position 1.
 - Input and output level as with setting “1“
- Parameter 270 = 4** - Setting the sensor to position 1.
 - Position 2 is set according to the angular degree setting by means of parameter 271.
 - Start measuring from trailing edge position 1.
 - Input and output level as with setting “1“
- Parameter 270 = 5** - There is no position sensor. The drive stops unpositioned. The thread trimmer is suppressed.

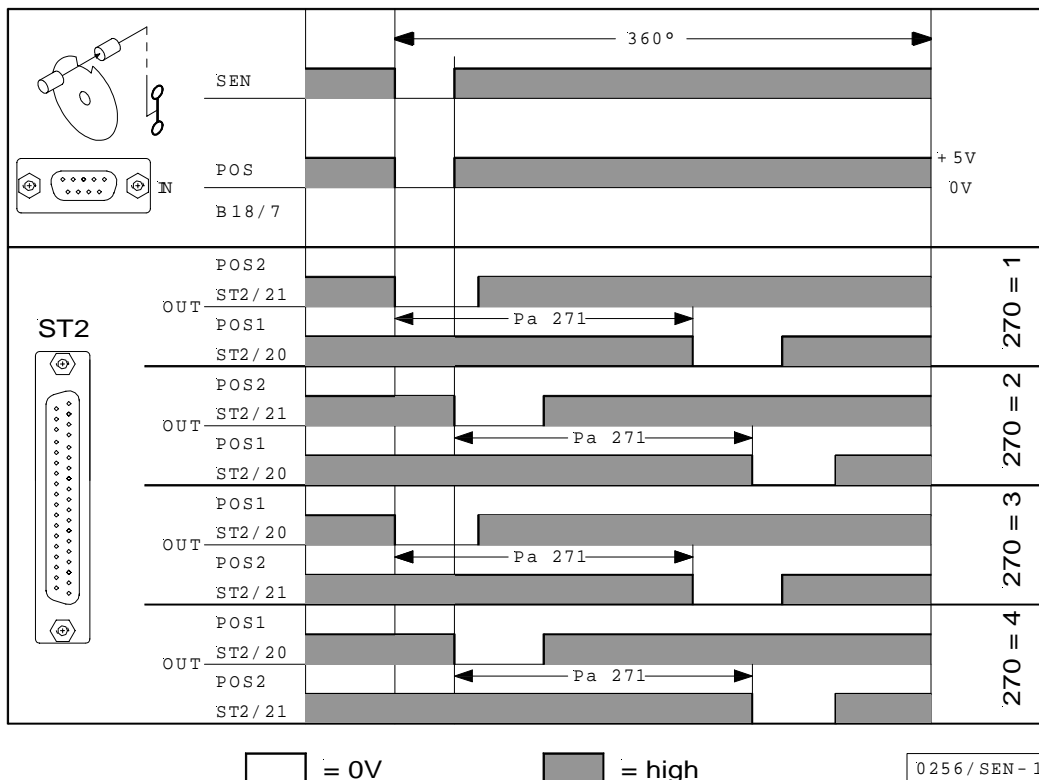

Connection of a sensor e. g. light barrier or proximity switch to socket B18/7. The following settings are possible using parameter 270:

- Parameter 270 = 1** - Setting the sensor to position 2.
 - Position 1 is set according to the angular degree setting by means of parameter 271.
 - Start measuring from trailing edge position 2.
 - 0V at input B18/7 (inside of the window)
 - +5V at input B18/7 (outside of the window)
- Parameter 270 = 2** - Setting the sensor to position 2.
 - Position 1 is set according to the angular degree setting by means of parameter 271.
 - Start measuring from leading edge position 2.
 - Input and output level as with setting "1"
- Parameter 270 = 3** - Setting the sensor to position 1.
 - Position 2 is set according to the angular degree setting by means of parameter 271.
 - Start measuring from trailing edge position 1.
 - Input and output level as with setting "1"
- Parameter 270 = 4** - Setting the sensor to position 1.
 - Position 2 is set according to the angular degree setting by means of parameter 271.
 - Start measuring from leading edge position 1.
 - Input and output level as with setting "1"

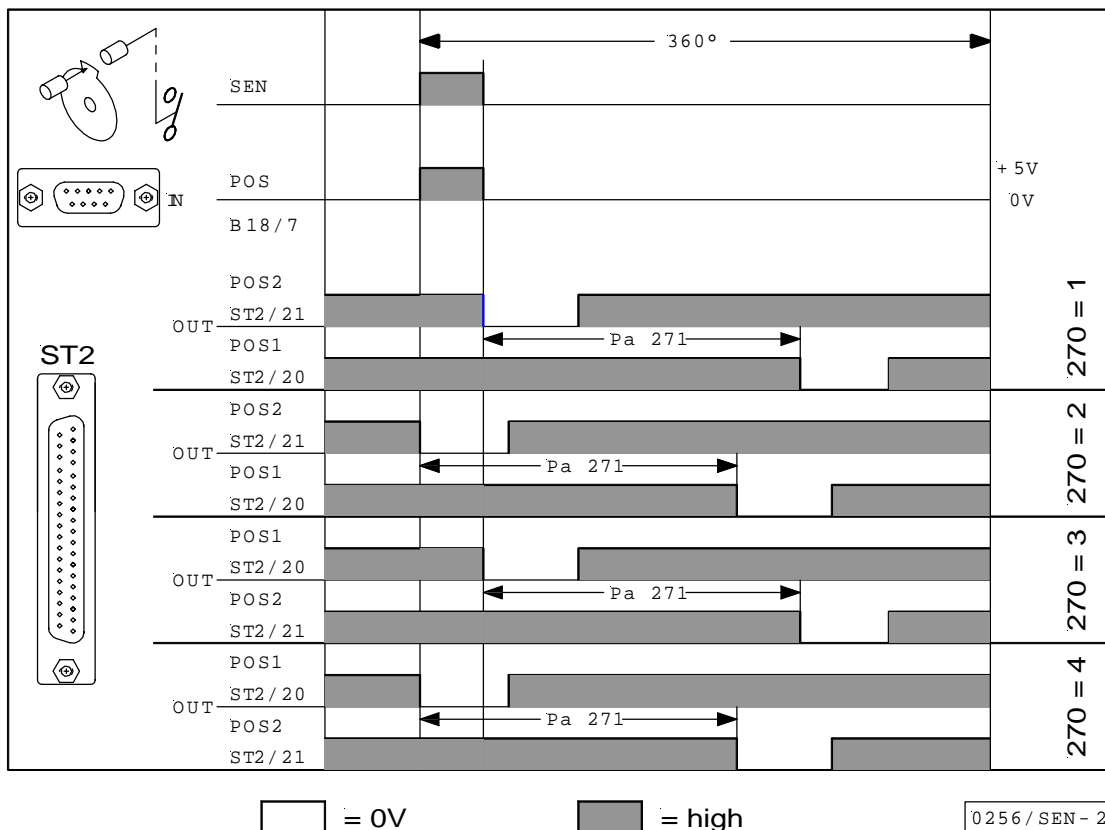

OUT (position window) = npn transistor (emitter to 0V) is conductive.
 Width of position window cannot be adjusted.

8.8.1 Setting the Reference Position (Parameter 270 = 0)

The angular positions necessary on the machine e.g. “needle down position“ or “thread lever up position“ are stored in the control. A reference position is needed in order to establish a relationship between position transmitter information and actual mechanical position.

The reference position must be set:

- for initial operation
- after replacing the motor
- after replacing the microprocessor

Setting the reference position on the control

- Input code number and select parameter 170.
- Press the **E** key → Display **Sr1**
- Press the >> key → Display **P o** (character o rotating)
- Turn handwheel until rotating character **o** goes off on the display. → Display **P**
- The set the needle to the bottom dead center by turning the handwheel. → Set machine reference point
- Press the **P** key once → Actual parameter number is displayed
- Press the **P** key twice → Exit programming at the technician level

Setting the reference position on the V810 control panel

- Input code number and select parameter 170.
- Press the **E** key → Display **Sr1 [o]**
- Press the >> key → Display **PoS0 o** (character o rotating)
- Turn handwheel until rotating character **o** goes off on the display. → Display **PoS0**
- The set the needle to the bottom dead center by turning the handwheel. → Set machine reference point
- Press the **P** key once → Actual parameter number is displayed
- Press the **P** key twice → Exit programming at the technician level

Setting the reference position on the V820 control panel

- Input code number and select parameter 170.
- Press the **E** key → Display **F-170 Sr1 [o]**
- Press the >> key → Display **PoS0 o** (character o rotating)
- Turn handwheel until rotating character **o** goes off on the display. → Display **PoS0**
- The set the needle to the bottom dead center by turning the handwheel. → Set machine reference point
- Press the **P** key once → Actual parameter number is displayed
- Press the **P** key twice → Exit programming at the technician level

If error message A3 (reference position not set) appears, repeat the above setting sequence!

8.8.2 Setting the Positions on the Control (Parameter 270 = 0)

If parameter 270 = 0, the positions integrated in the motor are activated and can be set as follows:

- Input code number and select parameter 171.
- Press the **E** key → **[o]** is displayed
- Press the >> key → **P1E** is displayed; set “position 1 On“ on the handwheel
- Press the **E** key → **P2E** is displayed; set “position 2 On“ on the handwheel
- Press the **E** key → **P1A** is displayed; set “position 1 Off“ on the handwheel
- Press the **E** key → **P2A** is displayed; set “position 2 Off“ on the handwheel
- Press the **P** key twice → Exit programming at the technician level

8.8.3 Setting the Positions on the V810 Control Panel (Parameter 270 = 0)

If parameter 270 = 0, the positions integrated in the motor are activated and can be set as follows:

	Select parameter 171	→	F - 171
E	Press the E key	→	[o]
>>	Press the >> key (B key). Display of the 1st parameter value of position 1	→	P 1 E 140
+ -	If necessary, change parameter value by pressing the >> or +/- key or by turning the handwheel (> 1 rotation)	→	P 1 E XXX
E	Parameter value of position 2 appears on the display	→	P 2 E 260
+ -	If necessary, change parameter value by pressing the >> or +/- key or by turning the handwheel (> 1 rotation)	→	P 2 E XXX
E	Parameter value of position 1A appears on the display	→	P 1 A 080
+ -	If necessary, change parameter value by pressing the >> or +/- key or by turning the handwheel (> 1 rotation)	→	P 1 A XXX
E	Parameter value of position 2A appears on the display	→	P 2 A 400
+ -	If necessary, change parameter value by pressing the >> or +/- key or by turning the handwheel (> 1 rotation)	→	P 2 A XXX
P P	Press the P key twice. Settings are completed. Exit programming.	→	A b 220 A

These values are saved when you start sewing. They remain in effect even after turning the machine off!

8.8.4 Setting the Positions on the V820 Control Panel (Parameter 270 = 0)

If parameter 270 = 0, the positions integrated in the motor are activated and can be set as follows:

	Display before programming	→	4000 Ab220A
P	A parameter number blinks on the display	→	F-XXX
1 7 1	Input parameter number 171	→	F-171
E	The abbreviation of the parameter appears on the display	→	F-171 Sr2 [o]

»		Display of the 1st parameter value of position 1 (B key)	→	P1E 140		
0	...	9		If necessary, change parameter value by pressing the +/- or 0...9 keys or by turning the handwheel (>1 rotation).	→	P1E XXX
E		Parameter value of position 2 appears on the display	→	P2E 460		
0	...	9		If necessary, change parameter value by pressing the +/- or 0...9 keys or by turning the handwheel (>1 rotation).	→	P2E XXX
E		Parameter value of position 1A appears on the display	→	P1A 080		
0	...	9		If necessary, change parameter value by pressing the +/- or 0...9 keys or by turning the handwheel (>1 rotation).	→	P1A XXX
E		Parameter value of position 2A appears on the display	→	P2A 400		
0	...	9		If necessary, change parameter value by pressing the +/- or 0...9 keys or by turning the handwheel (>1 rotation).	→	P2A XXX
P	P	Settings are completed. Exit programming.	→	4000 Ab220A		

Note
When setting the positions by turning the handwheel, make sure that the displayed numerical value changes.

- The display unit of the set position values is “degrees“.

8.9 Display of the Signal and Stop Positions

Function with or without control panel		Parameter
Display of positions 1 and 2	(Sr3)	172

The position settings can easily be checked by means of parameter 172.

- Select parameter 172
- Without control panel, the control display shows "PoS"
- With control panel, the control panel display shows "Sr3"
- Turn handwheel according to the direction of motor rotation

Control display without control panel

- LED 7 on corresponds to position 1
- LED 7 turns off corresponds to position 1A
- LED 8 on corresponds to position 2
- LED 8 turns off corresponds to position 2A

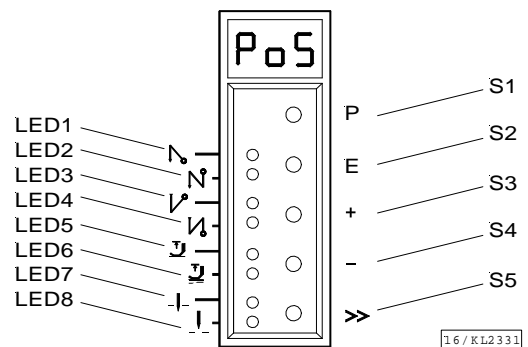

V810 control panel display

- Arrow above symbol "position 1" on the 4 key on
- Arrow above symbol "position 1" on the 4 key turns off
- Arrow above symbol "position 2" on the 4 key on
- Arrow above symbol "position 2" on the 4 key turns off

- corresponds to position 1
- corresponds to position 1A
- corresponds to position 2
- corresponds to position 2A

V820 control panel display

- Arrow above symbol "position 1" on the 7 key on corresponds to position 1
- Arrow above symbol "position 1" on the 7 key turns off corresponds to position 1A
- Arrow above symbol "position 2" on the 7 key on corresponds to position 2
- Arrow above symbol "position 2" on the 7 key turns off corresponds to position 2A

If the V810 or V820 control panel is connected, the positions will be displayed only on the control panel!

8.10 Positioning Shift

Function with or without control panel	Parameter
Positioning shift (PSv)	269

Determine by means of parameter 269 whether the drive is to stop exactly on the position (parameter 269 = 0) or some increments after the position.

8.11 Braking Characteristics

Function with or without control panel	Parameter
Braking effect when varying the preset value ≤ 4 stages (br1)	207
Braking effect when varying the preset value ≥ 5 stages (br2)	208

- Parameter 207 influences the braking effect for the stop
- Parameter 208 regulates the braking effect between speed stages

The following applies to all setting values:

The higher the value, the stronger the braking reaction!

8.12 Braking Power at Standstill

Function with or without control panel	Parameter
Braking power at standstill (brt)	153

This function prevents unintentional "wandering" of the needle at standstill. The effect can be checked by turning the handwheel.

- The braking power is effective at standstill
 - at stop in the seam
 - after the seam end
- The effect can be set
- The higher the set value, the stronger the braking power

8.13 Starting Characteristics

Function with or without control panel	Parameter
Starting edge (ALF)	220

The drive acceleration dynamics can be adapted to the sewing machine characteristic (light/heavy).

- High setting value = high acceleration

With a high starting edge setting and, in addition, possibly high braking parameter values on a light machine, the characteristic may appear coarse. In this case, one should try to optimize the settings.

8.14 Inputs for Proximity Switches

Function with or without control panel	Parameter
Switch proximity switches for inputs in2, in7, in8, in9 (nAm)	295

If parameter 295 is set at “1“, a load resistor is connected in parallel to inputs in2, in7, in8, in9, which allows to operate 2 wire proximity switches.

8.15 Actual Speed Display

Function with or without control panel	Parameter
Actual speed display (nIS)	139

If parameter 139 = 1, the V810/820 display shows the following information:

During operation:

- The actual speed
- **Example:** 2350 revolutions per minute

2350

2350

At stop in the seam:

- The stop indication



StoP

StoP

At standstill after trimming:

- On the V810, indication of the type of control
- On the V820, indication of the set maximum speed and the type of control
- **Example:** 3300 revolutions per minute and type of control AB220A



Ab220A

3300 Ab220A

9 Functions with or without Control Panel

9.1 Softstart

Function with or without control panel	Parameter
Softstart On/Off (SSt)	134

Functions:

- after power on
- at the beginning of a new seam
- speed pedal controlled and limited to (n6)
- lower speed of a parallel function prevailing (e. g. start backtack, stitch counting)
- stitch counting synchronized to position 1
- suspension with pedal in position 0 (neutral)
- interruption by full heelback (position -2)

When using the V820 control panel, direct access by means of the function key (9 key) is possible!

Function with control panel	Parameter
Softstart On/Off (-F-)	008 = 1

9.1.1 Softstart Speed

Function with or without control panel	Parameter
Softstart speed (n6)	115

When programming 3-digit or 4-digit parameter values on the control, the 2-digit or 3-digit values displayed must be multiplied by 10.

9.1.2 Softstart Stitches

Function with or without control panel	Parameter
Number of softstart stitches (SSc)	100

The letter symbols in parentheses () are visible only if the V820 control panel is connected!

9.2 Sewing Foot Lifting

Function without control panel	Control
Automatic in the seam Automatic after thread trimming	lefthand LED above key On righthand LED above key On S4 key S4 key

Function with control panel	V810	V820
Automatic in the seam Automatic after thread trimming If parameter 290 = 16, with slide-in strip "7"	lefthand arrow above key On righthand arrow above key On lefthand arrow above key On 3 key 3 key	6 key 6 key 9 key

Function with or without control panel		Parameter
Automatic sewing foot with pedal forward at the seam end if light barrier or stitch counting is On	(AFL)	023
Switch-on delay with pedal in position -1 (half heelback)	(t2)	201
Start delay after switching off the sewing foot lift signal	(t3)	202
Time of full power	(t4)	203
Duty ratio (ED) with pulsing	(t5)	204
Delay after thread wiping until sewing foot lifting	(t7)	206
Delay after thread trimming without thread wiper until sewing foot lifting	(tFL)	211
Selection of the sewing foot lift function	(FLP)	236
Upper limit ON period of sewing foot lifting 1...100	(EF-)	254

Sewing foot is lifted:

- in the seam
 - by half heelback (position -1)
 - or automatically (by means of the **S4** key on the control, lefthand LED lights up)
 - or automatically (by means of the **3** key on the V810 control panel)
 - or automatically (by means of the **6** key on the V820 control panel)
 - by pressing a key depending on the preselection of parameters 240...249
- after thread trimming
 - by heelback (position -1 or -2)
 - or automatically (by means of the **S4** key on the control, righthand LED lights up)
 - or automatically (by means of the **3** key on the V810 control panel)
 - or automatically (by means of the **6** key on the V820 control panel)
 - by pressing a key depending on the preselection of parameters 240...249
 - automatically by means of light barrier with pedal forward according to the setting of parameter 023
 - automatically by means of stitch counting with pedal forward according to the setting of parameter 023
 - switch-on delay after thread wiper (t7)
 - switch-on delay without thread wiper (tFL)

It is possible to prevent unintentional foot lifting before thread trimming when changing from pedal position 0 (neutral) to position -2 by setting a switch-on delay (t2) by means of parameter 201.

Holding power of the lifted foot:

The sewing foot is lifted by full power. Then the system switches automatically to partial power in order to reduce the load for the control and the connected solenoid.

Set the duration of full power by means of parameter 203 and the partial holding power by means of parameter 204.



CAUTION!

If the holding power is set too high, the solenoid and the control may be permanently damaged. Please observe the permissible duty ratio (ED) of the solenoid, and set the appropriate value according to the table below.

Value	Duty ratio (ED)	Effect
1	1 %	low holding power
100	100 %	high holding power (full power)

Sewing foot lowers:

- Press pedal to position 0 (neutral)
- Press pedal to position ½ (slightly forward)
- Release key for manual sewing foot lift

Upon pressing the pedal forward from lifted sewing foot, the start delay (t3) that can be set by means of parameter 202 becomes effective.

The following settings are possible with parameter 236:

- Parameter 236 = 0** Sewing foot lifting is possible from all positions.
- Parameter 236 = 1** Sewing foot lifting is possible only from position 2.
- Parameter 236 = 2** Sewing foot lifting is stored in pedal position -1 or -2. The storing can be undone by pressing the pedal slightly forward.

See List of Parameters chapter "**Timing Diagrams**"!

9.3 Start Backtack/Start Stitch Condensing

Function without control panel		Control
Single start backtack Double start backtack Start backtack Off	LED 1 On LED 2 On both LEDs Off	S2 key
Start stitch condensing On; number of stitches with stitch regulator (parameter 001) Start stitch condensing On; number of stitches without stitch regulator (parameter 000), after that number of stitches with stitch regulator (parameter 001) Start stitch condensing Off	LED 1 On LED 2 On both LEDs Off	S2 key

Function with control panel		V810/V820
Single start backtack Double start backtack Start backtack Off	lefthand arrow above key On righthand arrow above key On both arrows Off	1 key
Start stitch condensing On; number of stitches with stitch regulator (parameter 001) Start stitch condensing On; number of stitches without stitch regulator (parameter 000), after that number of stitches with stitch regulator (parameter 001) Start stitch condensing Off	lefthand arrow above key On righthand arrow above key On both arrows Off	1 key

The start backtack/start stitch condensing starts by pressing the pedal forward at the beginning of the seam. From lifted sewing foot the backtack is delayed by the time t3 (start delay after switching off the sewing foot lift signal). Start backtack as well as start stitch condensing are executed automatically at speed n3. They cannot be interrupted. If softstart is running parallel, the respective lower speed is prevailing.

If backtack synchronization (parameter 298) is off, the stitch regulator will be synchronized to position 1.

The stitch regulator will be switched off after completion of the stitch count (parameter 001) and the speed n3 after a delay time t1. Then pedal control is returned.

Counting is synchronized to position 1.

9.3.1 Speed n3 at the Start of the Seam

Function with or without control panel		Parameter
Start backtack/start stitch condensing speed	(n3)	112

When programming 3-digit or 4-digit parameter values on the control, the 2-digit or 3-digit values displayed must be multiplied by 10.

9.3.2 Stitch Counting for Start Backtack/Start Stitch Condensing

Function with or without control panel		Parameter
Number of stitches forward or without stitch regulator	(c2)	000
Number of stitches backward or with stitch regulator	(c1)	001

The start backtack/start stitch condensing stitches with or without stitch regulator can be programmed and varied by means of the above parameters directly on the control or on a connected V810/V820 control panel.

For fast operator information (HIT) when using the V820 control panel, the value of the function switched on by means of the **1** key can be displayed for approx. 3 seconds. During this time, the value can be varied directly by pressing the + or - key.

9.3.3 Stitch Correction and Speed Release

Function with or without control panel		Parameter
Stitch correction time	(t8)	150
Delay until speed release after start backtack	(t1)	200

Speed release after single and double backtack can be influenced by parameter 200.

In the case of slow backtack mechanisms it is possible to delay disabling of the stitch regulator in the single and double start backtack by the time t8 (start backtack stitch correction) and thereby prolong the backward section. This time-lag can be selected by means of parameter 150.

9.3.4 Double Start Backtack

The forward section will be sewn for a number of stitches that can be set. Then the stitch regulator signal will be issued and the backward section will be executed. The number of stitches for the two sections can be set separately.

9.3.5 Single Start Backtack / Start Stitch Condensing

The stitch regulator signal will be issued and the backward section and/or start stitch condensing will be executed for a number of stitches that can be set.

9.4 End Backtack / End Stitch Condensing

Function without control panel		Control
Single end backtack Double end backtack End backtack Off	LED 3 On LED 4 On both LEDs Off	S3 key
End stitch condensing On; number of stitches with stitch regulator (parameter 002) End stitch condensing On; number of stitches with stitch regulator (parameter 002), after that number of stitches without stitch regulator (parameter 003) End stitch condensing Off	LED 3 On LED 4 On both LEDs Off	S3 key

Function with control panel		V810	V820
Single end backtack Double end backtack End backtack Off	lefthand arrow above key On righthand arrow above key On both arrows Off	2 key	4 key
End stitch condensing On; number of stitches with stitch regulator (parameter 002) End stitch condensing On; number of stitches with stitch regulator (parameter 002), after that number of stitches without stitch regulator (parameter 003) End stitch condensing Off	lefthand arrow above key On righthand arrow above key On both arrows Off	2 key	4 key

The end backtack/end stitch condensing in a seam with stitch counting starts by heelback at the end of counting, or, from the light barrier seam at the end of the light barrier compensating stitches. The stitch regulator is immediately enabled from machine standstill. After lowering the sewing foot, the switch-on point of the stitch regulator is delayed by the time t3 (start delay after switching off the sewing foot lift signal). The first leading edge of position 1 counts as 0 stitch whenever the function is not started in position 1. If backtack synchronization (parameter 298) is not switched on, the stitch regulator is synchronized to position 1.

End backtack as well as end stitch condensing are performed automatically at speed n4. They cannot be interrupted.

From full machine run, end backtack / end stitch condensing will be switched in only after having reached the speed n4 and synchronization to position 2.

9.4.1 Speed n4 at the Seam End

Function with or without control panel	Parameter
End backtack/end stitch condensing speed (n4)	113

When programming 3-digit or 4-digit parameter values on the control, the 2-digit or 3-digit values displayed must be multiplied by 10.

9.4.2 Stitch Counting for End Backtack/End Stitch Condensing

Function with or without control panel	Parameter
Number of stitches forward or without stitch regulator (c3)	002
Number of stitches backward or with stitch regulator (c4)	003

The end backtack/end stitch condensing stitches with or without stitch regulator can be programmed and varied by means of the above parameters directly on the control or on a connected V810/V820 control panel.

For fast operator information (HIT) when using the V820 control panel, the value of the function switched on by means of the **4** key can be displayed for approx. 3 seconds. During this time, the value can be varied directly by pressing the + or - key.

9.4.3 Stitch Correction and Last Stitch Backward

Function with or without control panel	Parameter
Last stitch backward On/Off (FAr)	136
Stitch correction time (c9)	151

The backtack solenoid can be delayed in the double end backtack by selecting a stitch correction time (t9) by means of parameter 151.

For some sewing procedures it is desirable that the backtack solenoid in the single end backtack is disabled only after trimming. This function can be selected by means of parameter 136.

Parameter 136 = 0 last stitch forward
Parameter 136 = 1 last stitch backward

9.4.4 Double End Backtack/End Stitch Condensing

The backward section and/or end stitch condensing will be executed for a number of stitches that can be set. Then the stitch regulator will be disabled and the forward section and/or normal stitch condensing stitches will be executed. The number of stitches for the two sections can be set separately.

After stitch counting (parameter 003) the trimming function will be initiated. During the entire operation the sewing speed is reduced to speed n4, with the exception of the last stitch, which will be performed at positioning speed n1.

In the case of slow backtack mechanisms it is possible to delay disabling of the stitch regulator in the single and double end backtack by the time t9 (end backtack stitch correction).

9.4.5 Single End Backtack / End Stitch Condensing

The stitch regulator signal will be issued and the backward section and/or end stitch condensing will be executed for a number of stitches that can be set. During the last stitch the speed is reduced to positioning speed.

The letter symbols in parentheses () are visible only if the V820 control panel is connected!

9.4.6 Backtack Synchronization

Function with or without control panel		Parameter
Backtack synchronization for start and end backtack On/Off	(nSo)	298
Backtack synchronization speed	(nrS)	299

If parameter 298 is on, the backtack speed will be switched to backtack synchronization speed one stitch before engaging and disengaging of the backtack solenoid. The backtack speed is released at the next position 2. If the synchronization speed that can be set by means of parameter 299 is higher than the backtack speed, the latter is maintained. Backtack synchronization is possible in the start and end backtack.

9.5 Start Ornamental Backtack/Stitch Condensing

Function without control panel		Control
Function "ornamental backtack" On/Off		135
Ornamental backtack stop time		210
Single start ornamental backtack	LED 1 On	S2 key
Double start ornamental backtack	LED 2 On	
Start ornamental backtack Off	both LEDs Off	

Function with control panel		V810/V820
Function "ornamental backtack" On/Off	(SrS)	135
Ornamental backtack stop time	(tSr)	210
Single start ornamental backtack	lefthand arrow above key On	1 key
Double start ornamental backtack	righthand arrow above key On	
Start ornamental backtack Off	both arrows Off	

The parameters of the start backtack speed and the backtack stitches forward and backward are identical with the standard start backtack.

Difference from the standard start backtack:

- The drive stops for stitch regulator switching
- The stop time can be set

When using the V820 control panel, direct access by means of the function key (9 key) is possible!

Function with control panel		Parameter
Ornamental backtack On/Off	(-F-)	008 = 2

9.6 End Ornamental Backtack/Stitch Condensing

Function without control panel		Control
Function "ornamental backtack" On/Off		135
Ornamental backtack stop time		210
Single end ornamental backtack	LED 3 On	S3 key
Double end ornamental backtack	LED 4 On	
End ornamental backtack Off	both LEDs Off	

Function with control panel		V810	V820
Function "ornamental backtack" On/Off	(SrS)	135	135
Ornamental backtack stop time	(tSr)	210	210
Single end ornamental backtack	lefthand arrow above key On	2 key	4 key
Double end ornamental backtack	righthand arrow above key On		
End ornamental backtack Off	both arrows Off		

The parameters of the end backtack speed and the backtack stitches forward / backward are identical with the standard end backtack.

Difference from the standard end backtack:

- The drive stops for stitch regulator switching
- The stop time can be set

When using the V820 control panel, direct access by means of the function key (9 key) is possible!

Function with control panel	Parameter
Ornamental backtack On/Off (-F-)	008 = 2

9.7 Intermediate Backtack

Upon pressing an external key according to the preselection of parameters 240...249, the backtack solenoid can be switched on anywhere in the seam and at standstill.

See List of Parameters chapter **Connection Diagram!**

9.8 Stitch Regulator Suppression/Recall

Effective in standard and ornamental backtack

The next backtack and/or stitch condensing operation can be suppressed or recalled once by pressing an external key according to the preselection of parameters 240...249.

Upon pressing	Start backtack/ Stitch condensing On	Start backtack/ Stitch condensing Off	End backtack/ Stitch condensing On	End backtack/ Stitch condensing Off
Before start of seam	No backtack/ Stitch condensing	Backtack/ Stitch condensing	---	---
In the seam	---	---	No backtack/ Stitch condensing	Backtack/ Stitch condensing

The double backtack is performed in the above cases.

See List of Parameters chapter **Connection Diagram!**

9.9 Holding Power of the Stitch Regulator Solenoid

Function with or without control panel	Parameter
Time of full power (t10)	212
Holding power of the stitch regulator solenoid (t11)	213
Upper limit stitch regulator ON period (EV-)	255

The stitch regulator solenoid is engaged by full power. Then the system switches automatically to partial power in order to reduce the load for the control and the connected solenoid. Set the duration of full power by means of parameter 203 and the partial holding power by means of parameter 204.



CAUTION!

If the holding power is set too high, the solenoid and the control may be permanently damaged. Please observe the permissible duty ratio (ED) of the solenoid and set the appropriate value according to the table below.

Value	Duty ratio (ED)	Effect
1	1 %	low holding power
100	100 %	high holding power (full power)

9.10 Reverse Motor Rotation

Function with or without control panel		Parameter
Positioning speed	(n1)	110
Number of reversing degrees	(ird)	180
Switch-on delay of reverse motor rotation	(drd)	181
Reverse motor rotation On/Off	(Frd)	182

The function "reverse motor rotation" is performed after trimming. When the stop position is reached, the drive stops for the duration of the switch-on delay of reverse motor rotation. Then it runs in reverse direction at positioning speed according to the set degrees.

9.11 Unlocking the Chain (Mode 4/5/6/7/16)

Function with or without control panel		Parameter
Number of run-out stitches upon unlocking the chain	(c6)	184
Function "unlock the chain" in modes 4, 5, 6, 7 and 16	(MEk)	190

Upon unlocking the chain at the seam end, the functions **backtacking**, **chain suction**, **thread trimming** and **tape cutter/fast scissors** are automatically suppressed. If, however, parameter 190 = 3, the function **tape cutter/fast scissors** is possible. After pressing the key "unlocking the chain" and with pedal in position 0 (neutral), the drive always stops in position 1.

Settings necessary for the operation "unlocking the chain":

- Set "unlock the chain" by means of parameter 190 = 1 / 2 / 3 / 4 (190 = 0 "unlock the chain" off)
- Set **switch-on delay** by means of parameter 181 and **reversing angle** by means of parameter 180
- Determine the **function of the key "unlock the chain"** by means of one of the parameters 240...249
- If parameter 290 is set at "7", a switch at the input in1...i10 must be closed and programmed to "18".
- If parameter 290 is set at "16", the function "unlock the chain" must be switched on corresponding to slide-in strip 7 by means of the 8 key on the V820 control panel.

Parameter 190 = 0: Unlocking the chain Off

Parameter 190 = 1: Sequence with pedal in position -2 from machine run or from position 2:

- Press key "unlock the chain"
- Run at positioning speed to position 1
- Sequence of reversing angle at positioning speed after a switch-on delay that can be set

Parameter 190 = 1: Sequence with pedal in position -2 from standstill in position 1:

- Press key "unlock the chain"
- Sequence of reversing angle at positioning speed after a switch-on delay that can be set

Parameter 190 = 2: Automatic sequence with light barrier at the seam end without tape cutting / pedal in position -2 according to the setting of parameter 019:

- Press key "unlock the chain"
- Run to position 1 after light barrier sensing
- Sequence of reversing angle at positioning speed after a switch-on delay that can be set

Parameter 190 = 3 Automatic sequence with light barrier at the seam end with tape cutting and run-out stitches (only possible in modes 7 and 16 and if parameter 018 = 0):

- Press key "unlock the chain"
- After light barrier sensing, execution of compensating stitches and end counting until tape cutting
- Run-out stitches until unlocking the chain can be set by means of parameter 184
- Sequence of reversing angle at positioning speed after a switch-on delay that can be set

Parameter 190 = 4: Sequence with pedal in position -2 / no unlocking of the chain if seam end with light barrier, cutting and run-out stitches is set:

- Press pedal to position -2
- Run at positioning speed to position 1
- Sequence of reversing angle at positioning speed after a switch-on delay that can be set
- No unlocking of the chain at the seam end with light barrier
- Reverse motor rotation is suppressed when the drive stops. The signals “blow fabric onto stack”, M2 and “sewing foot lift” will be issued.

If parameter **290 = 16** and slide-in strip "7" has been selected for the V820 control panel, the following functions will be performed:

Function with V820 control panel	7 key	8 key
Standard sequence with tape cutting at the start of the seam and at the seam end	Off	Off
Unlocking the chain On according to the setting of parameter 190 = 0...4	On	Off
Unlocking the chain according to the setting of parameter 190 = 3	On/Off	On

See timing diagrams in the List of Parameters for operation characteristics of the control.

When using the V820 control panel, direct access by means of the function key (9 key) is possible!

Function with control panel	Parameter
Unlocking the chain On/Off	(-F-) 008 = 4

9.12 Machine Run Blockage (Safety Switch)



CAUTION!

This is not a safety function. The line voltage must still be switched off during maintenance and repair work.

The function “machine run blockage” is enabled by connecting a switch to socket ST2 or B4, depending on the preselection of parameters 240...249. When using a V810 / V820 control panel, an audible signal can be switched on and/or off by means of parameter 127.

Display after enabling machine run blockage without control panel:

Control display

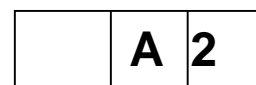

Display and signal after enabling machine run blockage with control panel:

V810 control panel display
(symbol blinks and audible signal
if parameter 127 = 1)



V820 control panel display
(symbol blinks and audible signal
if parameter 127 = 1)



Machine run blockage in the free seam, seam with stitch counting and light barrier seam:

The seam is suspended by opening and/or closing the switch.

- Stop in the basic position
- Needle up is not possible
- Sewing foot lift is possible

Machine run blockage in the start backtack / start stitch condensing:

The start backtack / start stitch condensing is interrupted by opening and/or closing the switch.

- Stop in the basic position
- Needle up is not possible
- Sewing foot lift is possible
- After disabling of the machine run blockage, the seam will be continued with the section following the start backtack / start stitch condensing

Machine run blockage in the end backtack / end stitch condensing:

The end backtack / end stitch condensing is interrupted, and the seam is completed by opening and/or closing the switch.

- Sewing foot lift is possible

New start after machine run blockage

Function with or without control panel	Parameter
New start after machine run blockage (Pdo)	234

Parameter 234 determines how a new start is possible after closing and/or opening the switch.

Parameter 234 = 0 New start after disabling machine run blockage without influence by the pedal. This setting is applicable, for example, to automats.

Parameter 234 = 1 New start after disabling machine run blockage only if the pedal is in position 0 (neutral).

9.13 High Lift for Walking Foot Signal Output M6 / Flip-Flop 1

Function with or without control panel	Parameter
High lift for walking foot On/Off (hP)	137
Signal "high lift for walking foot M6" when key is closed/open (ihP)	263

High lift for walking foot is effective only if input function 13 or 14 has been selected by means of parameters 240...249 and parameter 137 = 1. With all other settings high lift for walking foot is ineffective. The signal "machine at standstill" is issued at the corresponding output (M6). Select by means of parameter 263 whether the key is to be active when open or when closed.

Parameter 263 = 0 Signal "high lift for walking foot M6" is issued when key is closed

Parameter 263 = 1 Signal "high lift for walking foot M6" is issued when key is open

9.13.1 High Lift Walking Speed

Function with or without control panel	Parameter
High lift walking speed (n10)	117

9.13.2 High Lift Walking Speed Run-Out Time

Function with or without control panel	Parameter
High lift walking speed run-out time (thP)	152

9.13.3 High Lift Walking Stitches

Function with or without control panel	Parameter
Number of high lift walking stitches (chP)	185

Upon pressing the external key “high lift for walking foot” depending on the setting of parameters 240...249, the speed is limited to high lift walking speed. The solenoid for high lift for walking foot is switched on if the speed \leq high lift walking speed. It is possible to program run-out stitches by means of parameter 185. This way, high lift for walking foot remains on until stitch counting has been completed. The speed limitation remains effective during run-out time after the solenoid for high lift for walking foot has been switched off.

9.13.4 High Lift for Walking Foot Operational Mode Not Stored (Parameters 240...249 = 13)

The following function is performed if "0" run-out stitches have been programmed by means of parameter 185:

- Press key “high lift for walking foot”; signal “high lift for walking foot” is On.
- Release key “high lift for walking foot”; signal “high lift for walking foot” turns off.

The following function is performed if ">0" run-out stitches have been programmed by means of parameter 185:

- When the “high lift for walking foot” key is pressed for the first time at drive standstill, signal “high lift for walking foot” is enabled and remains On after releasing the key.
- When pressing the “high lift for walking foot” key” again at drive standstill, signal “high lift for walking foot” turns off.

If the signal “high lift for walking foot” is On when starting the drive, the speed will be limited. The signal turns off after the run-out stitches have been executed, and the speed limitation will be disabled after the run-out time (parameter 152). If the key is pressed down until after counting, high lift for walking foot remains On. If the key is pressed only briefly, counting takes priority.

While the drive is running, if ">0" run-out stitches have been programmed by means of parameter 185:

- Press key “high lift for walking foot” while drive is running; signal “high lift for walking foot” and high lift walking speed are On.
- Release key “high lift for walking foot” while drive is running; signal “high lift for walking foot” turns off after the run-out stitches have been executed, and the speed limitation will be disabled after the run-out time (parameter 152).

9.13.5 High Lift for Walking Foot Operational Mode Stored /Flip-Flop 1 (Parameters 240...249 = 14)

- 1. Press key “high lift for walking foot” while drive is running; signal “high lift for walking foot” and high lift walking speed are On.
- 2. Press key “high lift for walking foot” while drive is running; signal “high lift for walking foot” turns off immediately, and the speed limitation will be disabled after the run-out time (parameter 152).

9.14 Speed Depending on High Lift

9.14.1 Operating Mode of Speed Limitation Depending on High Lift

Functions	Parameter
Maximum speed (n2)	111
High lift walking speed (n10)	117
Speed depending on high lift with potentiometer (Pot)	126 = 3
Speed setting depending on high lift (hP)	188

- It is possible to program the assignment of the speed limitation to the 21 high lift levels.
- Minimum high lift = maximum speed (n2)
- Maximum high lift = minimum speed (n10)

Graduation of the examples below is as follows:

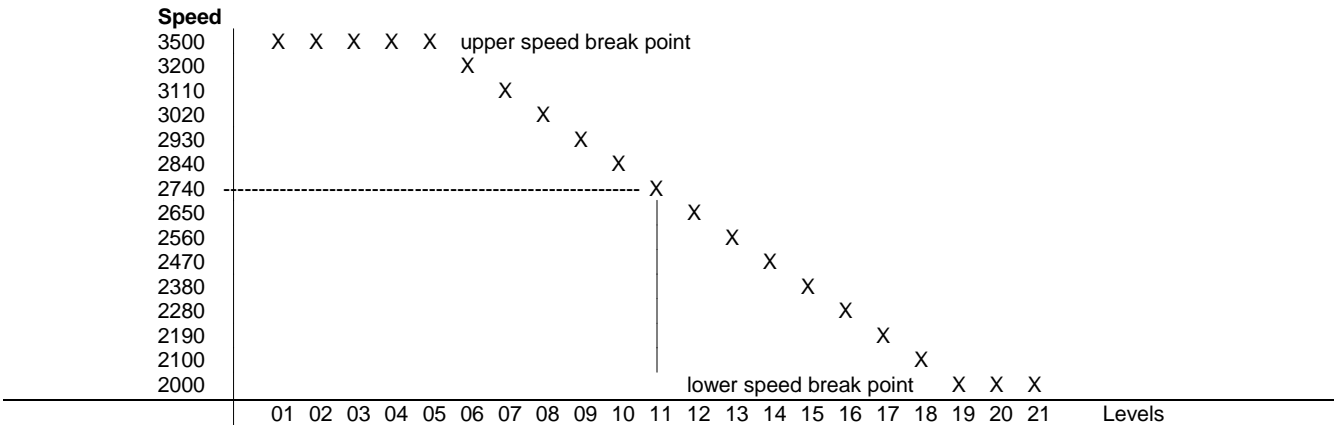

Display example of parameter 188 on the V820 control panel:

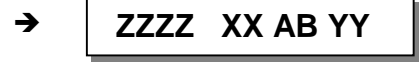

- Signification:** XX → Display of the level up to which the maximum speed is effective (upper break point).
- YY → Display of the level from which the maximum speed is effective (lower break point).
- AB → Display of the level set on the potentiometer.
- ZZZZ → Speed resulting from the set high lift level.
- EEEE → Outside of the speed range.

9.14.2 Setting the Speed Limitation Depending on High Lift with the V820 Control Panel

- Determine maximum speed (n2) by means of parameter 111.
- Determine minimum speed (n10) by means of parameter 117.
- Set parameter 126 to “3”.
- Call parameter 188.

- **E** Press the E key. → **F-188 hP [°]**

- **F2** Press the F2 key. → **ZZZZ XX AB YY**

Set high lift for walking foot (potentiometer on the machine) to the level up to which full speed is to be maintained (upper break point).

- **E** New value of **AB** is taken over to **XX**. → **ZZZZ XX AB YY**

Set high lift for walking foot (potentiometer on the machine) to the level from which minimum speed is to be effective (lower break point).

- **E** New value of **AB** is taken over to **YY**. → **ZZZZ XX AB YY**

Press **P** key once → Actual parameter is displayed. / Press **P** key twice → Exit programming.

9.14.3 Setting the Speed Limitation Depending on High Lift with the V810 Control Panel

- Call parameter 188.

- **E** Press the **E** key. → **hP [°]**

- **F2** Press the **F2** key. Actual display. → **11. 3200**

- **F2** Press the **F2** key. Previous values are displayed. → **05 19**

- **F2** Press the **F2** key. → **11. 3200**

- Set new value (level) with potentiometer on the machine. → **08. 3200**

- **F2** Press the **F2** key. → **05 19**

- **E** Press the **E** key. New value 08 (upper break point) is entered. → **08 08**

- **F2** Press the **F2** key. → **08. 3200**

- Set new value (level) with potentiometer on the machine. → **17. 3200**

- **F2** Press the **F2** key. → **08 08**

- **E** Press the **E** key. New value 17 (lower break point) is entered. → **08 17**

- **P** Press the **P** key once. Display of the actual parameter number. → **F - 188**

or

- **P** **P** Press the **P** key twice. Exit programming. → **A b 2 2 0 A**

These values are saved when you start sewing. They remain in effect even after turning the machine off!

Note

If you set a value on the potentiometer, which is between the actual break points, both values will be overwritten when pressing the **E** key. Only after that is it possible to program new lower and/or upper break point values.

9.14.4 Potentiometer Adjustment on JUKI Machine Model LU-2210/LU2260

1. Set potentiometer (A) in the machine head, which is accessible by a bore at the rear, to the left endstop.
2. Turn the handwheel to position 1 for the speed depending on high lift (minimum high lift).
3. Set parameter **126** to **3** (activation of external potentiometer for the speed depending on high lift).
4. Select parameter **188**. The V820 control panel display shows e. g.
5. Press the **F1** key, and the display shows e. g.
6. The display value should be **between 170 and 200**.
7. Is this the case, the adjustment is completed. Proceed with point 10.
8. Should the value be outside of the limits, there would be an audible signal.
9. Loosen the 4 screws on the machine head and remove the cover with the setting knob. Loosen adjusting screw (B) and turn the potentiometer shaft to set the value between the above limits. Then the audible signal will be switched off.
10. Press the **F1** key. The displayed value is taken over, and a short audible signal will be issued.
11. If the display shows **EEEE**, turn the potentiometer (A) in the machine head, which is accessible by a bore at the rear, to the right so that **EEEE** goes off, and level 1 (maximum speed) is displayed.

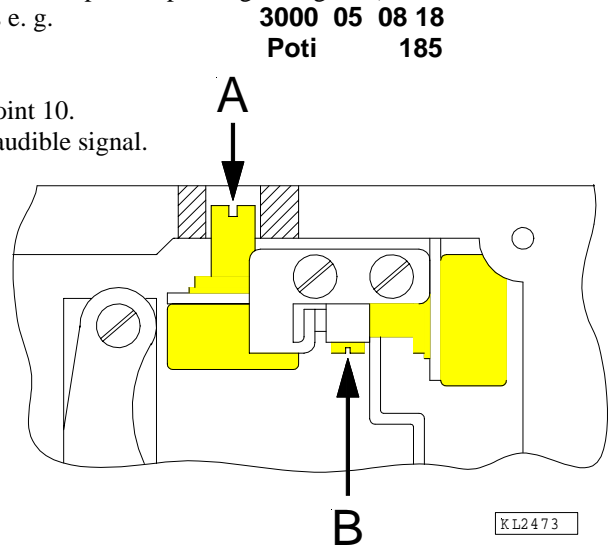

View of the machine head with open cover

9.15 Speed Limitation n9

Function with or without control panel	Parameter
Speed limitation n9	(n9) 122

If parameters 240...249 = 23, a speed limitation n9 will be switched on upon pressing an external key.

9.16 Speed Limitation n11 with Signal Output M10 / Flip-Flop 2

Function with or without control panel	Parameter
Speed limitation n11	(n11) 123
Disabling of flip-flop functions at the seam end On/Off	(FFm) 183
Function "speed limitation n11" inverted/non-inverted	(FFi) 186
Function of signal M10 on socket ST2/29 after "power on"	(FFo) 187

The speed limitation can be switched on by pressing a key on any of the inputs in1...i10 and switched off by pressing the key again. A signal output which can be programmed individually (inverted/non-inverted) is provided for the speed limitation. Furthermore, the function of signal output M10 can be determined after "power on".

Settings necessary for speed limitation n11

- Assign the function "speed limitation n11" to the key by means of one of the parameters 240...249 = 22. This function has a flip-flop effect.
- Determine by means of **parameter 186** whether signal M10 for speed limitation n11 shall be inverted or non inverted.
 - Parameter 186 = 0** Speed limitation n11 On/Signal M10 On or Speed limitation n11 Off/Signal M10 Off.
 - Parameter 186 = 1** Speed limitation n11 Off/Signal M10 On or Speed limitation n11 On/Signal M10 Off.
- Determine by means of **parameter 187** whether signal M10 shall be issued at socket ST2/29 after "power on".
 - Parameter 187 = 0** Signal M10 not active after "power on"; speed limitation n11 according to setting of parameter 186 (inverted/non-inverted)
 - Parameter 187 = 1** Signal M10 active after "power on"; speed limitation n11 according to setting of parameter 186 (inverted/non-inverted)

9.17 Disabling of Flip-Flop Functions at the Seam End

Function with or without control panel	Parameter
Disabling of flip-flop functions at the seam end On/Off (FFm)	183

Determine by means of parameter 183 whether signals M6 and/or M10 shall be switched off at the seam end. If 183 = 0, the signals can be switched off only by means of the appropriate keys.

Parameter 183 = 0 Signal M6 (flip-flop 1) and signal M10 (flip-flop 2) are not switched off at the seam end.

Parameter 183 = 1 Signal M6 (flip-flop 1) is switched off at the seam end.

Parameter 183 = 2 Signal M10 (flip-flop 2) is switched off at the seam end.

Parameter 183 = 3 Signal M6 (flip-flop 1) and signal M10 (flip-flop 2) are switched off at the seam end.

9.18 Bobbin Thread Monitor

Function with or without control panel	Parameter
Bobbin thread monitor 0 = Off / 1 = with stop / 2 = without stop / 3 = with stop and start blockage after thread trimming (rFw)	030
Number of bobbin thread monitor stitches (cFw)	031

For bobbin thread monitor operation a number of stitches depending on the length of the bobbin thread is preset by means of parameter 031. After the execution of these stitches the drive stops and a visual signal appears on the display. If a control panel is connected, an audible signal is also issued if parameter 127 is set accordingly. This signals that the bobbin thread will run out. After pressing the pedal again, the seam can be continued and the thread can be trimmed. After inserting a full bobbin and pressing the ENTER key, a new sewing operation can be started.

Enable bobbin thread monitor:

- Set parameter 030 to "1...3".
- Input the desired maximum number of stitches in parameter 031 (input value x 100 = number of stitches, e. g. 80 x 100 = 8000).
- For starting the counter set the A or B key at "19" by means of parameter 293 or 294.
- When using a control panel, an audible signal can also be enabled by means of parameter 127.
- Start the sewing operation.

Bobbin thread monitor in operation:

- **Parameter 030 = 0:** Bobbin thread monitor is off.
- **Parameter 030 = 1:** The drive stops after the stitch counter has run out. The message "A7" appears on the control, and the bobbin thread monitor symbol blinks on the V810/V820 control panel, respectively. There will be an audible signal if a V820 is connected and parameter 127 is set at "1".
- **Parameter 030 = 2:** The drive stops after the stitch counter has run out. The message "A7" appears on the control, and the bobbin thread monitor symbol blinks without stopping automatically on the V810/V820 control panel, respectively. There will be an audible signal if a V820 is connected.
- **Parameter 030 = 3:** The drive stops after the stitch counter has run out. Thread trimming is possible with pedal in pos. -2. The start is blocked. The message "A7" appears on the control, and the bobbin thread monitor symbol blinks on the V810/V820 control panel, respectively. There will be an audible signal if a V820 is connected and parameter 127 is set at "1".
- **Parameter 030 = 4:** Function as with parameter 030 = 1, but remaining stitches will be displayed.
- **Parameter 030 = 5:** Function as with parameter 030 = 1, but remaining stitches will be displayed.
- **Parameter 030 = 6:** Function as with parameter 030 = 1, but remaining stitches will be displayed.

Getting the bobbin thread monitor ready for operation:

- Insert a full bobbin.
- Press the selected external key, or the appropriate key on the connected control panel (8 key on the V820).
- Set counting to the value determined by parameter 031 and start it.
- The symbol stops blinking, and the message "A7" on the control will be switched off after trimming.

9.19 Thread Trimming Operation

Function with or without control panel		Parameter
Thread trimmer On/Off	(FA)	013
Thread wiper On/Off	(FW)	014

Function with control panel	V820
Thread trimmer or thread wiper On/Off	5 key

When a V820 control panel is connected, the functions can also be switched on and off by means of the 5 key.

9.19.1 Thread Trimmer/Thread Wiper (Modes 0, 2, 3, 10, 14, 20 and 23)

Function with or without control panel		Parameter
Thread wiper time	(t6)	205
Holding power output M1 of the thread trimmer backward	(t11)	213
Thread trimmer activation angle	(iFA)	250
Thread tension release switch-off delay	(FSA)	251
Thread tension release switch-on delay	(FSE)	252
Stop time for thread trimmer	(tFA)	253
Upper limit ON period of thread trimmer backward	(EV-)	255

Thread trimming on lockstitch machines (modes 0...3, 10, 14, 20 and 23) is performed at trimming speed.

When thread trimming is off, the drive stops in position 2 at the seam end; it stops in position 1 at the end of programmed seams.

On lockstitch machines, the thread wiper ON period can be set depending on the selected trimming mode (see chapter "Timing Diagrams" in the List of Parameters). The return time (t7) that can be set by means of parameter 206 prevents sewing foot lifting before the thread wiper is in its initial position. If the thread wiper is not connected, there will be a delay time (tFL) after thread trimming until sewing foot lifting.

9.19.2 Trimming Speed

Function with or without control panel		Parameter
Trimming speed	(n7)	116

9.19.3 Chainstitch Thread Trimmer (Modes 4, 5, 6, 21 and 24)

Thread trimming on chainstitch machines (modes 4, 5, 6, 21 and 24) is performed at machine standstill in position 2. When thread trimming is off, the drive stops in position 2 at the seam end. The signal sequence of M1...M4 and of the sewing foot can be set as desired by means of parameters 280...288 (parallel or sequential).

9.19.4 Chainstitch Machine Trimming Signal Times

Signal delay times and ON periods can be set with the help of the following parameters.

Function with or without control panel		Parameter
Delay time output M1	(kd1)	280
ON period output M1	(kt1)	281
Delay time output M2	(kd2)	282
ON period output M2	(kt2)	283
Delay time output M3	(kd3)	284
ON period output M3	(kt3)	285
Delay time output M4	(kd4)	286
ON period output M4	(kt4)	287
Delay time until sewing foot On	(kdF)	288
ON period output M7 (signal if parameter 290 = 16)	(kt5)	289

See timing diagrams in the List of Parameters for operation characteristics of the control. See also chapter "Selection of Functional Sequences (Thread Trimming Operations)".

9.20 Bag Sewing Machine Functions (Mode 5)

Function with or without control panel		Parameter
Chainstitch machine functions e. g. bag sewing machine functions	(Sak)	198

There are various setting possibilities in mode 5 using parameter 198:

- Parameter 198 = 0** Thread trimming or hot thread chain cutting and sewing foot lifting are enabled by means of the pedal.
- Parameter 198 = 1** Thread trimming or hot thread chain cutting is enabled by means of the knee switch, and the sewing foot is lifted using the pedal.
- Parameter 198 = 2** Thread trimming or hot thread chain cutting is enabled by means of the pedal, and the sewing foot is lifted by means of the knee switch.

For bag sewing machine operation the parameters indicated below must be adapted manually. See List of Parameters chapter "Timing Diagrams" mode 5 (bag sewing machine) for the values. For the knee switch select an input in1...i10, and set the corresponding parameter to "42".

Function with or without control panel		Parameter
Delay time output M2	(kd2)	282
ON period output M2 (impulse)	(kt2)	283
Delay time output M3 for hot thread chain cutting	(kd3)	284
ON period output M3 for hot thread chain cutting	(kt3)	285
Delay time until sewing foot On	(kdF)	288
Input for knee switch function	(in1...i10)	240...249

9.21 Stitch Lock Machine Functions (Mode 21)

Function with or without control panel		Parameter
Stitch lock function On/Off	(StL)	196

The following settings are possible using parameter 196:

- Parameter 196 = 0** The stitch lock function is off. Output ST2/34 operates as stitch condensing.
- Parameter 196 = 1** The stitch lock function is on. Output ST2/34 operates as stitch lock and output ST2/28 (M2) as stitch condensing. **Note that the output functions have been switched! Pay particular attention when connecting a different sewing machine!**

The corresponding values are set automatically in mode 21! See table in chapter "Preset Values Depending on Mode".

9.22 Functions for Pegasus MHG-100 Machine (Mode 24)

Function with or without control panel		Parameter
Delay time from light barrier uncovered to release of light barrier speed n5	(dnL)	158
Stitch counting until signal M9 Off	(cb2)	159

The corresponding values are set automatically in mode 24! See table in chapter “Preset Values Depending on Mode“. See timing diagrams in the List of Parameters for functions of this machine model.

9.23 Overlock Machine Functions (Mode 7)

9.23.1 Chain Suction Signal

The chain suction signal can be preselected for start and end counting, respectively, by means of the **S2** key on the control and the **1** key on the V810/V820 control panel. If chain suction and tape cutter are switched off at the start of the seam, the respective counts will be suppressed. But they will be performed at the seam end.

Function without control panel		Control
Chain suction at the start of the seam On	LED 1 On	S2 key
Chain suction at the seam end On	LED 2 On	

Function with control panel		V810/V820
Chain suction at the start of the seam On	lefthand arrow above key On	1 key
Chain suction at the seam end On	righthand arrow above key On	

Function with or without control panel		Parameter
Sequence overlock mode (modes 7/16) with or without stop	(UoS)	018
Chain suction signal at the seam end until end of count c2 or until pedal in pos.0 (neutral)	(SPO)	022
Start counting (pa. 157) for thread tension release at the start of the seam	(tFS)	025
Speed during stitch counting at the start of the seam	(kSA)	143
Speed during stitch counting at the seam end	(kSE)	144
Stitches until thread tension release Off after light barrier covered at the start of the seam	(SFS)	157
Enable chain suction and thread tension release signal at the seam end	(kSL)	193
Thread tension release On at the seam end until pedal in pos. 0 (neutral) or until the next start of a seam	(FSn)	199
Braking curve in overlock mode On/Off	(bdO)	235
Switch-off delay for chain suction at the seam end if parameter 022 = 2	(tkS)	237

There are various setting possibilities with the following parameters in the overlock mode (mode 7).

- Parameter 018 = 0** Sequence with stop.
- Parameter 018 = 1** Sequence without automatic stop at the seam end. When the command “run” is given, the drive runs at the preselected speed. The program switches to the next start of a seam without issuing signals M1/M2, when the pedal is in pos. 0 (neutral) or the light barrier is covered.
- Parameter 018 = 2** Sequence as with setting 1. But signals M1/M2 will be issued when the pedal is in pos. 0 (neutral), and the program switches to the next start of a seam.
- Parameter 018 = 3** Sequence as with setting 1. But signals M1/M2 will be issued when the pedal is in pos. -2, and the program switches to the next start of a seam. Intermediate stop and sewing foot lifting with pedal in pos. -1 is possible.
- Parameter 022 = 0** The chain suction signal at the seam end is disabled after count c2.
- Parameter 022 = 1** The chain suction signal at the seam end remains on until pedal in pos. 0 (neutral).
- Parameter 022 = 2** Chain suction until the drive is at standstill and the switch-off delay (parameter 237) has elapsed. The switch-off delay will be disabled whenever a new seam is started.
- Parameter 025 = 0** Start counting for thread tension release at the start of the seam.
- Parameter 025 = 1** Start counting for thread tension release when the light barrier is covered.

- Parameter 193 = 0** Thread tension release and chain suction after the light barrier compensating stitches.
Parameter 193 = 1 Chain suction from light barrier uncovered onwards and thread tension release after the light barrier compensating stitches.
- Parameter 199 = 0** Thread tension release On at the seam end until pedal in pos. 0 (neutral).
Parameter 199 = 1 Thread tension release On at the seam end or at the start of the seam.
Parameter 199 = 2 Thread tension release On at the seam end or at the start of the seam and after “power On“.
- Parameter 235 = 0** Braking curve Off.
Parameter 235 = 1 Braking curve On for precise stop upon chain suction at the seam end.
- It is possible to select the speed function for stitch counting at the start of the seam and at the seam end by means of the following parameters.
- Parameter 143 = 0** Speed controllable by the pedal up to the set maximum speed (parameter 111).
Parameter 143 = 1 Fixed speed (parameter 112) without influence by the pedal. Stop with pedal in pos. 0 (neutral).
Parameter 143 = 2 Limited speed (parameter 112) controllable by the pedal up to the set limit.
Parameter 143 = 3 At fixed speed (parameter 112), can be suspended or interrupted depending on the setting of parameter 019.
- Parameter 144 = 0** Speed controllable by the pedal up to the set maximum speed (parameter 111).
Parameter 144 = 1 Fixed speed (parameter 113) without influence by the pedal. Stop with pedal in pos. 0 (neutral).
Parameter 144 = 2 Limited speed (parameter 113) controllable by the pedal up to the set limit.
Parameter 144 = 3 At fixed speed (parameter 113), can be suspended or interrupted depending on the setting of parameter 019.

9.23.2 Start and End Counts

Function with or without control panel		Parameter
End count (c2) at limited speed n4 until stop	(c2)	000
Start count (c1) at limited speed n3 for chain suction	(c1)	001
Count (c3) tape cutter at the start of the seam	(c3)	002
End count (c4) for tape cutter at the seam end	(c4)	003
Seam end in mode 7 through end count (c2) or (c4)	(MHE)	191
Stitch counting speed at the start of the seam	(n3)	112
Stitch counting speed at the seam end	(n4)	113

The following settings are possible for determining the seam end by means of parameter 191:

- Parameter 191 = 0** Seam end after count c4 (tape cutter)
Parameter 191 = 1 Seam end after count c2 (chain suction)

9.24 Function of Output Signal M8

Function with or without control panel		Parameter
Functions of signal M8	(m08)	296

The following settings are possible using parameter 296:

- Parameter 296 = 0** Function signal M8 Off
Parameter 296 = 1 Signal M8 “hemmer foot” is On at the start of the seam with pedal in pos. <0 and in the seam with signal “machine running”.
Parameter 296 = 2 Signal M8 “hemmer foot” is On at the start of the seam with pedal in pos. <0 and always in the seam.
Parameter 296 = 3 Signal M8 enabled as “center cutter“.
Parameter 296 = 4 Signal M8 is On with “needle up / down“.
Parameter 296 = 5 Signal M8 alternates with M3 when set as “fast scissors“ on overlock machines (parameter 290 = 16 and parameter 232 = 1).

9.25 Function of Output Signal M11

Function with or without control panel	Parameter
Functions of signal M11	(m11) 297

The following settings are possible using parameter 297:

- Parameter 297 = 0** Function according to setting of parameter 290
- Parameter 297 = 1** Signal M11 is On whenever the light barrier is uncovered.
- Parameter 297 = 2** Signal M11 is On whenever the light barrier is covered.
- Parameter 297 = 3** Signal M11 is On only after light barrier uncovered or covered until seam end.
- Parameter 297 = 4** Signal M11 is On as with setting 3. Signal M5 (machine running), however, is Off while signal M11 is On.

9.26 Tape Cutter/Fast Scissors (Modes 6/7/15/16)

9.26.1 Functions for Mode 6

The signal **tape cutter/fast scissors** is issued only at the seam end. A manual tape cutter/fast scissors can also be set. See also chapter "**Manual Tape Cutter/Fast Scissors**".

Function with or without control panel	Parameter
Tape cutter at the seam end On/Off	014

Output and Times for Tape Cutter

Function with or without control panel	Parameter
Delay time for output M3 (ST2/27) tape cutter AH	(kd3) 284
ON period for output M3 (ST2/27) tape cutter AH	(kt3) 285

- Parameter **232** must be set at "**0**".
- The delay time for the tape cutter is usually set at "**0**".

Output and Times for Fast Scissors

Function with or without control panel	Parameter
Delay time for output M3 (ST2/27) fast scissors AH1	(kd3) 284
ON period for output M3 (ST2/27) fast scissors AH1	(kt3) 285
Delay time for output M4 (ST2/36) fast scissors AH2	(kd4) 286
ON period for output M4 (ST2/36) fast scissors AH2	(kt4) 287

- Parameter **232** must be set at "**1**".
- The delay times for "fast scissors" are usually set at "**0**".

9.26.2 Functions for Mode 7

The signal **tape cutter/fast scissors** can be set separately for start and end counting. See also chapter "**Manual Tape Cutter/Fast Scissors**".

Function without control panel	Control
Tape cutter/Fast scissors at the start of the seam On	LED 3 On
Tape cutter/Fast scissors at the seam end On	LED 4 On
Tape cutter/Fast scissors at the start and at the end of the seam On	LED 3 and 4 On
Tape cutter/Fast scissors at the start and at the end of the seam Off	LED 3 and 4 Off

S3 key

- When using the V810 control panel, parameter 291 will automatically be set to slide-in strip "7" if 290 = 7.
- When using the V820 control panel, parameter 292 will automatically be set to slide-in strip "5" if 290 = 7.

Function with control panel	V810	V820
Tape cutter/Fast scissors at the start of the seam On	lefthand arrow above key On	4 key
Tape cutter/Fast scissors at the seam end On	righthand arrow above key On	
Tape cutter/Fast scissors at the start and at the end of the seam On	both arrows above key On	
Tape cutter/Fast scissors at the start and at the end of the seam Off	both arrows above key Off	

The tape cutter signal can be influenced by parameter 020 in such a way that the signal remains on at the seam end and is off when you start sewing again after some run-out stitches, which can be set by means of parameter 021. This action serves as clamp.

Function with or without control panel		Parameter
Clamp at the seam end (output ST2/27) On/Off (mode 7)	(kLm)	020
Run-out stitches (ckL) of the clamp at the start of the seam (mode 7) or stitch counting after light barrier uncovered until tape cutter On (mode 15)	(ckL)	021

Output and Times for Tape Cutter

Function with or without control panel		Parameter
Delay time for output M3 (ST2/27) tape cutter AH	(kd3)	284
ON period for output M3 (ST2/27) tape cutter AH	(kt3)	285

- Parameter **232** must be set at "0".
- The delay time for the tape cutter is usually set at "0".

Output and Times for Fast Scissors

Function with or without control panel		Parameter
Delay time for output M3 (ST2/27) fast scissors AH1	(kd3)	284
ON period for output M3 (ST2/27) fast scissors AH1	(kt3)	285
Delay time for output M4 (ST2/36) fast scissors AH2	(kd4)	286
ON period for output M4 (ST2/36) fast scissors AH2	(kt4)	287

- Parameter **232** must be set at "1".
- The delay times for "fast scissors" are usually set at "0".

9.26.3 Functions for Mode 15

Function without control panel		Control
Count c1 and c2 On/Off	LED 1/2	S2 key
Counts c3 and c4 On/Off	LED 3/4	S3 key
Functions of sewing foot lifting On/Off	LED 5/6	S4 key
Basic position 1 or 2	LED 7/8	S5 key

- The **tape cutter** signal can be set separately for start and end counting.
- When using the V820 control panel, parameter 292 will automatically be set to slide-in strip "5" if 290 = 15.

Function with control panel	V820
Chain suction/blowing at the start of the seam and/or at the seam end On/Off	1 key
Stitch counting On/Off	2 key
Light barrier On/Off	3 key
Tape cutter at the start of the seam and/or at the seam end On/Off	4 key
Chain blowing On/Off	5 key
Sewing foot in the seam and/or at the seam end On/Off	6 key
Basic position 1 or 2	7 key
Set bobbin thread monitor to the preset value	8 key
Reverse motor rotation On/Off	9 key
No function	0 key

Output and Times for Tape Cutter

Function with or without control panel		Parameter
Counting after light barrier uncovered until tape cutter M4 On	(ckL)	021
Tape cutter function	(USS)	232
Delay time of output VR for chain suction	(kt6)	256
Start counting until tape cutter M4 On	(c7)	257
End counting until tape cutter M4 On	(c8)	258
Delay time until tape cutter M4 On	(kd4)	286
ON period tape cutter M4	(kt4)	287

Tape cutter function after enabling output M6:

- The seam end is initiated by light barrier uncovered.
- Counting (ckL) is initiated at the same time.
- After counting, tape cutter M4 will be activated for the time (kt4).
- After the delay time (kd4), tape cutter M4 will be activated for the time (kt4) for the 2nd time.
- At standstill of the drive the tape cutter operation (double tape cutting) can be repeated any number of times by pressing the key (setting parameter 244 = 15) connected to socket ST2/5.

Tape cutter function when output M6 is disabled:

- At the start of the seam, the tape cutter will be activated for the time (kt4) after a number of stitches (c7) that can be set by means of parameter 257.
- After light barrier sensing, the tape cutter will be activated for the time (kt4) at the seam end after a number of stitches (c8) that can be set by means of parameter 258.
- At standstill of the drive the tape cutter operation (double tape cutting) can be repeated any number of times by pressing the key (setting parameter 244 = 15) connected to socket ST2/5.

See also List of Parameters chapter “**Timing Diagrams**“!

9.26.4 Functions for Mode 16

Function without control panel		Control
Count c1 On/Off	LED 1/2	S2 key
Counts c3 and c4 On/Off	LED 3/4	S3 key
Functions of sewing foot lifting On/Off	LED 5/6	S4 key
Basic position 1 or 2	LED 7/8	S5 key

- The signal **tape cutter/fast scissors** can be set separately for start and end counting.
- The V810 control panel cannot be used if parameter 290 = 16 (mode 16).
- When using the V820 control panel, parameter 292 will automatically be set to slide-in strip "7" if 290 = 16.

Function with control panel	V820
Tape cutter/Fast scissors at the start of the seam On/Off	1 key
Tape cutter/Fast scissors at the seam end On/Off	2 key
Light barrier On/Off	3 key
Chain suction On/Off	4 key
Blow fabric onto stack from light barrier uncovered onwards On/Off	5 key
Tape cutting at the seam end On/Off	6 key
Reverse motor rotation On/Off	7 key
Unlocking the chain On/Off	8 key
Sewing foot in the seam and/or at the seam end On/Off	9 key
Basic position 1 or 2	0 key

The **7** and **8** key settings on the V820 control panel have priority over the setting of parameter 019.

Functions	2 key	6 key
Tape cutting at the seam end Off, count c4 until stop	Off	Off
Tape cutting at the seam end On, count c4 until stop	On	Off
Tape cutting at the seam end Off, count c3 until stop	On/Off	On

Output and Times for Tape Cutter

Function with or without control panel		Parameter
Delay time for output M3 (ST2/27) tape cutter AH	(kd3)	284
ON period for output M3 (ST2/27) tape cutter AH	(kt3)	285

- Parameter **232** must be set at "0".
- The delay time for the tape cutter is usually set at "0".

Output and Times for Fast Scissors

Function with or without control panel		Parameter
Delay time for output M3 (ST2/27) fast scissors AH1	(kd3)	284
ON period for output M3 (ST2/27) fast scissors AH1	(kt3)	285
Delay time for output M8 (ST2/24) fast scissors AH2	(kd4)	286
ON period for output M8 (ST2/24) fast scissors AH2	(kt4)	287
Selection of signal M8 functions	(m08)	296

- Parameter **232** must be set at "1".
- The delay times for "fast scissors" are usually set at "0".

Function "Blow Fabric onto Stack"

Function with or without control panel		Parameter
Function "blow fabric onto stack"	(bLA)	194
ON period for output M7	(kt5)	289

- Parameter 194 = 0** Blow fabric onto stack (output M7) at the seam end over the time (kt5), which can be set by means of parameter 289.
- Parameter 194 = 1** Blow fabric onto stack (output M7) from light barrier uncovered to seam end; after the seam end over the time (kt5).

See also List of Parameters chapter "Timing Diagrams"!

9.27 Manual Tape Cutter/Fast Scissors

Upon pressing an external key depending on the preselection of parameters 240...249, the **tape cutter** or **fast scissors** can be enabled anywhere in the seam or at standstill.

See chapter "Connection Diagram" in the List of Parameters!

9.28 Manual Stacker

Function with or without control panel		Parameter
Stacker function with open/closed key	(iS1)	264
ON period for manual stacker	(ktS)	265

After pressing the key that has been allocated for the purpose, a stacker signal will be issued for a certain period of time (parameter 265) at output M7 (socket ST2/23). Select the key by means of one of parameters 240...249. The manual stacker function is possible in all modes except mode 16.

Parameter 240...249 = 26 Allocation of the key for the manual stacker signal.

Parameter 264 = 0 Signal “manual stacker” (output M7), when key is closed.

Parameter 264 = 1 Signal, “manual stacker” (output M7), when key is open.

Parameter 265 ON period of manual stacker signal.

9.29 Selection of Signals M8, M9 and M10 at the Start of the Seam

Function with or without control panel		Parameter
Signals M8, M9, M10 On/Off (0 = Off / 1 = On)	(ASi)	273
Delay time for signal M8 at the start of the seam	(Ad1)	274
Signal M8 ON period at the start of the seam	(At1)	275
Delay time for signal M9 at the start of the seam	(Ad2)	276
Signal M9 ON period at the start of the seam	(At2)	277
Delay time for signal M10 at the start of the seam	(Ad3)	278
Signal M10 ON period at the start of the seam	(At3)	279

Three different signals (M8, M9, M10) can be programmed for various applications at the start of the seam. These can be enabled and disabled by means of parameter 273. Select delay times and ON periods by means of parameters 274...279.

9.30 Seam with Stitch Counting

Function without control panel		Parameter
Stitch counting On/Off		015

Function with control panel		Parameter
Stitch counting On/Off		V820 2 key

9.30.1 Stitches for Stitch Counting

Function with or without control panel		Parameter
Number of stitches for a seam with stitch counting	(Stc)	007

The stitch counting stitches can be programmed and varied by means of the above parameters directly on the control or on a connected V810/V820 control panel.

For fast operator information (HIT) when using the V820 control panel, the value of the function switched on by means of the **2** key can be displayed for approx. 3 seconds. During this time, the value can be varied directly by pressing the + or - key.

9.30.2 Stitch Counting Speed

Function with or without control panel		Parameter
Positioning speed	(n1)	110
Stitch counting speed	(n12)	118
Speed mode for a seam with stitch counting	(SGn)	141
Activation of speed n12 when key is open/closed	(ktS)	266

Speed control for stitch counting can be selected by means of parameter 141.

Parameter 141 = 0 Execution at pedal controlled speed.

Parameter 141 = 1 Execution at fixed speed n12, when pressing the pedal forward (position >1).

Parameter 141 = 2 Execution at limited speed n12, when pressing the pedal forward (position >1).

Parameter 141 = 3 Automatic execution at fixed speed after having pressed the pedal once. The procedure can be interrupted by "heelback (-2)".

Parameter 141 = 4 Automatic execution at fixed speed after having pressed the pedal once. The procedure can be interrupted by "heelback (-2)".

Parameter 266 = 0 Speed n12 is activated when key is closed.

Parameter 266 = 1 Speed n12 is activated when key is open.

The sewing speed is reduced in each stitch depending on the actual speed (max. 11 stitches before the end of stitch counting), in order to be able to stop exactly at the end of counting. When the light barrier is on, free sewing will be performed after stitch counting.

9.30.3 Seam with Stitch Counting When Light Barrier Is On

Function with or without control panel		Parameter
Light barrier On/Off	(LS)	009
Stitch counting On/Off	(StS)	015

Function with control panel		V820
Light barrier On/Off		3 key
Stitch counting On/Off		2 key

When "stitch counting and light barrier function " is set, the number of stitches will be executed first, then the light barrier will be activated.

9.31 Free Seam and Seam with Light Barrier

Function with or without control panel		Parameter
Positioning speed	(n1)	110
Upper limit of maximum speed	(n2)	111
Limited speed according to setting of 142	(n12)	118
Lower limit of maximum speed	(n2_)	121
Speed mode free seam	(SFn)	142

Speed control for the free seam and the seam with stitch counting can be selected by means of the speed mode.

Parameter 142 = 0 Execution at pedal controlled speed

Parameter 142 = 1 Execution at fixed speed n12, when pressing the pedal forward (position >1)

Parameter 142 = 2 Execution at limited speed n12, when pressing the pedal forward (position >1)

Parameter 141 = 3 Only for the seam with light barrier:

- Automatic execution at fixed speed after having pressed the pedal once.

- The seam end is initiated by light barrier.

- The procedure can be interrupted by heelback (-2).

- If the light barrier is not on, speed as with parameter setting 142 = 0.

When using a control panel, the maximum speed is displayed after power on and thread trimming and can be varied directly by means of the +/- keys on the control panel. The setting range lies between the values of parameters 111 and 121.

9.32 Light Barrier

Function with or without control panel	Parameter
Light barrier On/Off	009

Function with control panel	Parameter
Light barrier covered/uncovered On Light barrier uncovered/covered On Light barrier Off	righthand arrow above key On lefthand arrow above key On both arrows Off 3 key

The light barrier function at the input of socket B18/5 is active only if parameter 239 = 0.

9.32.1 Speed after Light Barrier Sensing

Function with or without control panel	Parameter
Speed after light barrier sensing (n5)	114

9.32.2 General Light Barrier Functions

Function with or without control panel	Parameter
Light barrier compensating stitches (LS)	004
Number of light barrier seams (LSn)	006
Light barrier sensing uncovered/covered (LSd)	131
Start of sewing blocked/unblocked with light barrier uncovered (LSS)	132
Light barrier seam end with thread trimming On/Off (LSE)	133
Speed of the light barrier compensating stitches (PLS)	192

- After sensing the seam end, the compensating stitches are counted at light barrier speed.
- Suspension of the procedure with pedal in pos. 0 (neutral). Interruption of the procedure with pedal in pos. -2.
- The thread trimming operation can be disabled by means of parameter 133, regardless of the 5 key setting on the V820 control panel. Stop in the basic position.
- Programming of max. 15 light barrier seams depending on the setting of parameter 006 with stop in the basic position. Thread trimming after the last light barrier seam.
- Light barrier sensing uncovered or covered at the seam end can be selected by means of parameter 131.
- Start blockage with light barrier uncovered programmable by means of parameter 132.
- Speed selection pedal controlled / n5 during the light barrier compensating stitches by means of parameter 192.

The light barrier compensating stitches can be programmed and varied by means of the above parameters directly on the control or on a connected V810/V820 control panel.

For fast operator information (HIT) when using the V820 control panel, the value of the function switched on by means of the 3 key can be displayed for approx. 3 seconds. During this time, the value can be varied directly by pressing the + or - key.

When using the V820 control panel, direct access by means of the function key (9 key) is possible!

Function with control panel	Parameter
Start of sewing blocked with light barrier uncovered On/Off (-F-)	008 = 3

9.32.3 Reflection Light Barrier LS002

Sensitivity setting:

Set minimum sensitivity depending on the distance between light barrier and reflection area (turn potentiometer as far as possible to the left).

- Potentiometer directly on the light barrier module

Mechanical orientation:

Orientation is facilitated by a visible light spot on the reflection area.

9.32.4 Light Barrier Monitoring

Function with or without control panel	Parameter
Stitches for light barrier monitoring (LSc)	195

In order to check the optical and electrical function it is possible to select a number of stitches by means of parameter 195. While these stitches are performed, the light barrier must be activated at least once. When the count is completed and the light barrier has not been activated, the drive stops and the message A6 appears.

- Select a number of stitches that is larger than necessary for the seam.
- The function is off if the number of stitches is "0".

9.32.5 Automatic Start Controlled by Light Barrier

Function with or without control panel	Parameter
Delay of automatic start (ASd)	128
Automatic start On/Off (ALS)	129
Light barrier sensing uncovered (LSc)	131
Start of sewing blocked with light barrier uncovered (LSS)	132

This function enables an automatic start of the sewing operation as soon as the light barrier senses the insertion of fabric.

Prerequisites for the operation:

- Parameter 009 = 1 (light barrier On).
- Parameter 129 = 1 (automatic start On).
- Parameter 131 = 1 (light barrier sensing uncovered).
- Parameter 132 = 1 (no start of sewing with light barrier uncovered).
- The pedal must be kept pressed forward at the seam end.

For safety reasons this function is enabled only after a normal start of sewing. The light barrier must be covered as long as the pedal is in position 0 (neutral). Then press the pedal forward. This function is disabled when the pedal is no longer pressed forward after the seam end.

9.32.6 Light Barrier Filter for Knitted Fabrics

Function with or without control panel	Parameter
Number of stitches of the light barrier filter (LSF)	005
Light barrier filter On/Off (LSF)	130
Light barrier sensing uncovered or covered (LSc)	131

The filter prevents premature enabling of the light barrier function when sewing knitted fabrics.

- Enabling/Disabling of the filter by means of parameter 130
- The filter is not active if parameter 005 = 0
- Adaptation to the mesh is possible by varying the number of filter stitches.
- Knitted fabric sensing with light barrier uncovered → covered, if parameter 131 = 0
Knitted fabric sensing with light barrier covered → uncovered, if parameter 131 = 1

9.32.7 Functional Variations of the Light Barrier Input

Function with or without control panel	Parameter
Selection of the input function on socket B18/5	239

If the light barrier function is not used, a switching function can be assigned to the input on socket B18/5 as well as to inputs in1...i10.

The following input functions are possible with parameter 239:

Parameter 239 = 0 **Light barrier function:** The input is prepared for a light barrier function.

Parameter 239 = 1...47 **All other input functions are identical with those described for parameter 240 below.**

9.33 Switching Functions of Inputs in1...i10

Function with or without control panel	Parameter
Selection of the input function (in1...i10)	240...249

A variety of functions can be selected for each input on sockets ST2 and B4.

The following input functions are possible with parameters 240...249:

- 240 = 0** **Input function blocked**
- 240 = 1** **Needle up/down:** Upon pressing the key, the drive runs from position 1 to position 2 or from position 2 to position 1. If the drive is not in the stop position, it runs to the preselected basic position.
- 240 = 2** **Needle up:** Upon pressing the key, the drive runs from position 1 to position 2.
- 240 = 3** **Single stitch (basting stitch):** Upon pressing the key, the drive performs one rotation from position 1 to position 1. If the drive is in position 2, it runs to position 1 upon pressing the key and from position 1 to position 1 each time the key is pressed again.
- 240 = 4** **Full stitch:** Upon pressing the key, the drive performs a full rotation depending on the set stop position.
- 240 = 5** **Needle to position 2:** If the drive is not in position 2, it runs to position 2 upon pressing the key.
- 240 = 6** **Machine run blockage effective with open contact:** Upon opening the switch, the drive stops in the preselected basic position.
- 240 = 7** **Machine run blockage effective with closed contact:** Upon closing the switch, the drive stops in the preselected basic position.
- 240 = 8** **Machine run blockage effective with open contact (unpositioned):** Upon opening the switch, the drive stops immediately unpositioned.
- 240 = 9** **Machine run blockage effective with closed contact (unpositioned):** Upon closing the switch, the drive stops immediately unpositioned.
- 240 = 10** **Run at automatic speed (n12):** Upon pressing the key, the drive runs at automatic speed. The pedal is not used. (This input function is inverted in mode 9.)
- 240 = 11** **Run at limited speed (n12):** Upon pressing the key, the drive runs at limited speed. The pedal must be pressed forward.
- 240 = 12** **Sewing foot lifting with pedal in position 0 (neutral)**
- 240 = 13** **High lift for walking foot operational mode not stored:** The signal "high lift for walking foot" is issued as long as the key is pressed down, and the drive runs with speed limitation (n10).
- 240 = 14** **High lift for walking foot operational mode stored /flip-flop 1:** The signal "high lift for walking foot" is issued upon briefly pressing the key, and the drive runs with speed limitation (n10). The operation is disabled upon pressing the key again.
- 240 = 15** **Tape cutter or fast scissors (mode 6/7):** Upon pressing the key, the tape cutter will be enabled for a preset time.
- 240 = 16** **Intermediate backtack / Intermediate stitch condensing:** Upon pressing the key, the backtack or stitch condensing will be enabled anywhere in the seam and at standstill of the drive.
- 240 = 17** **Stitch regulator suppression / recall:** Upon pressing the key, the backtack or stitch condensing operation will be suppressed or recalled once.
- 240 = 18** **Unlocking the chain:** Upon pressing the key, the motor performs a reverse rotation at the seam end. Moreover, backtacking and thread trimmer will be suppressed.
- 240 = 19** **Reset bobbin thread monitor:** After inserting a full bobbin, the stitch counter is set to the value determined by means of parameter 031.
- 240 = 20** **Handwheel running in the direction of rotation:** Upon pressing the key, the drive runs in the direction of rotation according to the setting of parameter 161.

240 = 21	Handwheel running in the direction of rotation: Upon pressing the key, the drive runs in the opposite direction of rotation according to the setting of parameter 161.
240 = 22	Speed limitation n11 (flip-flop 2): Upon pressing the key in the seam, the speed limitation n11 is enabled, and a signal is issued at the output ST2/29. The speed limitation will be disabled upon pressing the key again, and the signal at the output is no longer issued.
240 = 23	No function
240 = 24	No function
240 = 25	Speed limitation with external potentiometer: Upon pressing the key, the external speed limitation becomes effective. Parameter 126 must be set at "2".
240 = 26	Manual stacker: Upon pressing the key, the function is performed in all modes (except mode 16).
240 = 27	Unlocking the chain: Upon pressing the key, the function "unlock the chain" will be performed without using the pedal.
240 = 28	External light barrier: In this mode it is possible to initiate the seam end by means of a key, not by means of the light barrier. But the light barrier function must be On.
240 = 29	Hemmer foot signal off: See parameter 296. This function is effective only in the seam.
240 = 30	High lift for walking foot: Upon pressing the key, high lift for walking foot is enabled if the sewing foot is On.
240 = 31	Function "speed limitation bit0": Upon pressing the bit0 key, speed n11 will be enabled. Upon simultaneously pressing the bit0 and bit1 keys, speed n9 will be enabled.
240 = 32	Function "speed limitation bit1": Upon pressing the bit1 key, speed n10 will be enabled. Upon simultaneously pressing the bit0 and bit1 keys, speed n9 will be enabled.
240 = 33	Speed n9: Below this speed, operation can be pedal controlled.
240 = 34	Automatic speed n9: The speed can be suspended by pressing the pedal to position 0.
240 = 35	Automatic speed n9: The speed can be interrupted by pressing the pedal to position -2.
240 = 36	Automatic speed n9: No influence by the pedal.
240 = 37	Speed n12 with break contact: Below this speed, operation can be pedal controlled.
240 = 38	Automatic speed n12 with break contact: Not influenced by the pedal.
240 = 39	Switch to the next pattern in TEACH IN: Upon pressing the key, the program switches to the next pattern.
240 = 40	Switch back to the previous pattern TEACH IN: Upon pressing the key, the program switches to the previous pattern.
240 = 41	Tape cutting only at machine standstill.
240 = 42	Enable hot thread chain cutting or sewing foot lifting: This function is effective only in the chainstitch mode.
240 = 43...47	No function

Input functions of parameters 241...249 are identical with those described for parameter 240.

9.34 Software Debouncing of All Inputs

Functions	Parameter
Software debouncing of all inputs	(EnP) 238

Parameter 238 = 0 No debouncing

Parameter 238 = 1 Debouncing

9.35 F1/F2 Function Key Assignment on the V810/V820 Control Panels

Functions	Parameter
Selection of input function on the (A) key "F1" on the V810/V820 control panels	(tF1) 293
Selection of input function on the (B) key "F2" on the V810/V820 control panels	(tF2) 294

The following functions are possible using parameters 293 and 294:

293/294 = 0 **Input function blocked**

293/294 = 1 **Needle up/down:** Upon pressing the key, the drive runs from position 1 to position 2 or from position 2 to position 1. If the drive is not in the stop position, it runs to the preselected basic position.

293/294 = 2	Needle up: Upon pressing the key, the drive runs from position 1 to position 2.
293/294 = 3	Single stitch (basting stitch): Upon pressing the key, the drive performs one rotation from position 1 to position 1. If the drive is in position 2, it runs to position 1 upon pressing the key and from position 1 to position 1 each time the key is pressed again.
293/294 = 4	Full stitch: Upon pressing the key, the drive performs a full rotation depending on the stop position.
293/294 = 5	Needle to position 2: If the drive is not in position 2, it runs to position 2 upon pressing the key.
293/294 = 6...12	No function
293/294 = 13	High lift for walking foot operational mode not stored: The signal “high lift for walking foot” is issued as long as the key is pressed down, and the drive runs with speed limitation (n10).
293/294 = 14	High lift for walking foot operational mode stored /flip-flop 1: The signal “high lift for walking foot” is issued upon briefly pressing the key, and the drive runs with speed limitation (n10). The operation is disabled upon pressing the key again.
293/294 = 15	Tape cutter or fast scissors (mode 6/7): Upon pressing the key, the tape cutter will be enabled for a preset time.
293/294 = 16	Intermediate backtack: Upon pressing the key, the backtack will be enabled anywhere in the seam and at standstill of the drive.
293/294 = 17	Backtack suppression / recall: Upon pressing the key, the backtack will be suppressed or recalled once.
293/294 = 18	No function
293/294 = 19	Reset bobbin thread monitor: After inserting a full bobbin, the stitch counter is set to the value determined by means of parameter 031.

9.36 Functioning of Handwheel when Pressing a Key

Function with or without control panel		Parameter
Selection of handwheel increments carried out when the key is pressed once	(ihr)	260
Speed for the handwheel	(nhr)	261
Delay time until the key is pressed down causing the handwheel to rotate continuously	(ihP)	262

The handwheel can be set in motion by pressing a key. Select the key by means of one of the parameters 240...249.

Parameters 240...249 = 20 Direction of rotation of the handwheel according to the setting of parameter 161.

Parameters 240...249 = 21 Direction of rotation of the handwheel opposite to that set by means of parameter 161.

Parameter 260 Selection of the number of increments to be performed after pressing a key.

Parameter 261 Setting the speed for the handwheel.

Parameter 262 Setting the delay time. When pressing the key briefly, i.e. no longer than the time set by means of 262, the increments set by means of parameter 260 are performed at the speed set by means of parameter 261. When keeping the key pressed down, the handwheel runs continuously until the key is released at the speed set by means of parameter 261.

9.37 Speed Limitation by means of External Potentiometer

Function with or without control panel		Parameter
Speed limitation by means of external potentiometer (maximum value)	(toP)	124
Speed limitation by means of external potentiometer (minimum value)	(bot)	125
Function “speed limitation with external potentiometer”	(Pot)	126

A speed limitation can be set by means of external potentiometer using parameters 124 and 125. The external potentiometer can be connected to sockets ST2/2, ST2/3 and ST2/4.

Parameter 124: Maximum value for speed limitation with external potentiometer

Parameter 125: Minimum value for speed limitation with external potentiometer

The following functions for speed limitation are possible by means of external potentiometer using parameter 126:

Parameter 126 = 0 Function “external potentiometer” Off.

Parameter 126 = 1 The external potentiometer is active whenever the pedal is pressed forward. The drive always runs with the set speed limitation.

Parameter 126 = 2 The external potentiometer is active only if an input is set at "25" by means of parameters 240...249. If the selected input is enabled and the pedal pressed forward, the drive runs at limited speed. The speed limitation can be enabled and disabled anywhere in the seam by means of the key.

Parameter 126 = 3 Speed depending on high lift with potentiometer e.g. Juki (LU-2210/2260).

Parameter 126 = 4 Speed depending on high lift with potentiometer e.g. Dürkopp Adler (767).

9.38 Signals A1 and A2

When using the V820 control panel, direct access by means of the function key (9 key) is possible!

Function with control panel	Parameter
Signal A1 and/or A2 On/Off with slide-in strip 1...4 (lefthand arrow = A1, righthand arrow = A2)	(-F-) 008 = 5

Function with control panel	V820
Signal A1 On Signal A2 On Signals A1 and A2 On Signals A1 and A2 Off	left hand arrow above key On right hand arrow above key On both arrows above key On both arrows above key Off 8 key

Signals A1 and A2 can be assigned to a seam by means of the 8 key on the V820 control panel (slide-in strips 6, 8, 9 and 10). The parameters described below determine the moment in which the signals are assigned in the seam and how long these signals are active. The example below illustrates the various possibilities (if parameter 320 = 0).

		Parameter											
A1	301	302	303	304	305	308	309	NA	LS-D	NE	FA-E	P=0	
A2	311	312	313	314	315	318	319						
				[m s]	[m s]	[St]	[St]						
	0	0	0	0	0	0	0						1)
	0	0	0	0	0	0	0						2)
	1	0	0	0	100	0	0	100	100				
	1	0	1	100	100	0	0	100	100				
	3	0	0	0	0	0	10	10					
	3	0	2	0	0	10	10	10	10				
	3	0	1	100	0	0	10	100	100				
	1	0	2	0	100	10	0	10	100				
	2	0	0	0	0	0	0						1)
	2	0	0	0	0	0	0						2)
	0	0	1	100	0	0	0	100					
	0	0	2	0	0	10	0	10					
	1	3	0	0	100	0	0	100	100				
	1	3	1	100	100	0	0	100	100				
	3	3	0	0	0	0	10	10					
	3	3	2	0	0	10	10	10	10				
	3	3	1	100	0	0	10	100	100				
	1	3	2	0	100	10	0	10	100				
	2	3	0	0	0	0	0						
	0	3	0	0	0	0	0						
	0	3	1	100	0	0	0	100					
	0	3	2	0	0	10	0	10					
	2	3	1	100	0	0	0	100					
	2	3	2	0	0	10	0	10					

		Parameter										
A1	301	302	303	304	305	308	309	NA	LS	NE	FA-E	P=0
A2	311	312	313	314 [m s]	315 [m s]	318 [St]	319 [St]					
	0	1	0	0	0	0	0					
	0	1	1	100	0	0	0		100			
	0	1	2	0	0	10	0		10			
	1	1	0	0	100	0	0		100			
	1	1	1	100	100	0	0		100	100		
	3	1	0	0	0	0	10		10			
	3	1	2	0	0	10	10		10	10		
	3	1	1	100	0	0	10		100	10		
	1	1	2	0	100	10	0		10	100		
	1	2	0	0	100	0	0			100		
	1	2	1	100	100	0	0			100	100	

0256 / B LD4

NA = Start of seam LS-D = Light barrier covered at the start of the seam P=0 = Pedal in pos. 0 (neutral)
 NE = Seam end LS = Light barrier uncovered or covered at the seam end FA-E = Thread trimming end

- 1) Seam end after stitch counting or light barrier sensing
- 2) Seam end after the pedal has been pressed to pos. -2

Different power transistors can be selected by means of parameter 300 for signal A1 and parameter 310 for signal A2.

- Parameter 300/310 = 0 → No function
- 1 → Signal A1 / A2 at output M1
 - 2 → Signal A1 / A2 at output M2
 - 3 → Signal A1 / A2 at output M3
 - 4 → Signal A1 / A2 at output M4
 - 5 → Signal A1 / A2 at output M5
 - 6 → Signal A1 / A2 at output M6
 - 7 → Signal A1 / A2 at output M7
 - 8 → Signal A1 / A2 at output M8
 - 9 → Signal A1 / A2 at output M9
 - 10 → Signal A1 / A2 at output M10
 - 11 → Signal A1 / A2 at output M11
 - 12 → Signal A1 / A2 at output VR

It is possible to select by means of **parameter 301** for signal A1 and **parameter 311** for signal A2, whether the signals On until the seam end or during a programmable time.

- Parameter 301/311** 0 → Signal A1 / A2 active until seam end
 1 → Signal A1 / A2 effective during a programmable time

It is possible to select by means of **parameter 302** for signal A1 and **parameter 312** for signal A2, whether the signals shall be effective at the start of the seam, after light barrier sensing or at the seam end.

- Parameter 302/312** 0 → Signal A1 / A2 start at the beginning of the seam
 1 → Signal A1 / A2 start after light barrier sensing
 2 → Signal A1 / A2 start at the seam end

It is possible to select by means of **parameter 303** for signal A1 and **parameter 313** for signal A2, whether the signals shall be activated with or without delay.

- Parameter 303/313** 0 → Signal A1 / A2 activated without delay time
 1 → Signal A1 / A2 activated with delay time

The delay times can be selected separately for signal A1 by means of **parameter 304** and for signal A2 by means of **parameter 314**.

The ON periods can be selected separately for signal A1 by means of **parameter 305** and for signal A2 by means of **parameter 315**.

The speed mode can be set separately for signal A1 by means of **parameter 306** and for signal A2 by means of **parameter 316**. The speed limitation is effective only when the respective signal is On.

Parameter 306/316

0	→	Pedal controlled speed
1	→	Limited to speed n9 (parameter 288) when signal is issued
2	→	Limited to speed n11 (parameter 289) when signal is issued

The signals can be enabled or disabled separately for signal A1 by means of **parameter 307** and for signal A2 by means of **parameter 317**.

It is possible to select by means of **parameter 308** for signal A1 and **parameter 318** for signal A2, whether the signals shall be activated with or without delay stitches.

Parameter 308/318

0	→	Signal A1 / A2 activated without delay stitches
1	→	Signal A1 / A2 activated with delay stitches

Separate stitch counts can be selected for signal A1 by means of **parameter 309** and for signal A2 by means of **parameter 319**.

The switch-off moment for signals A1 and A2 can be set by means of **parameter 320**.

Parameter 320

0	→	Signals effective until seam end
1	→	Signals effective until pedal has been pressed to pos. 0 (neutral)

9.39 Signal "Machine Running"

Function with or without control panel	Parameter
Mode "machine running" (LSG)	155
Switch-off delay for signal "machine running" (t05)	156

Parameter 155 = 0 Signal "machine running" Off.

Parameter 155 = 1 Signal "machine running" will be issued whenever the drive is running.

Parameter 155 = 2 Signal "machine running" will be issued whenever the speed is higher than 3000 RPM.

Parameter 155 = 3 Signal "machine running" will be issued whenever the pedal is not in position 0 (neutral).

Parameter 155 = 4 Signal "machine running" will be issued only after motor synchronization (one rotation at positioning speed after power On).

The signal switch-off time can be delayed by means of parameter 156.

9.40 Signal Output Position 1

- Transistor output with open collector
- Signal whenever the needle is in the slot between position 1 and 1A
- Independent of sewing, thus also when turning the handwheel manually
- Suitable e. g. for the connection of a counter
- An inverted signal is issued at socket ST2/20

9.41 Signal Output Position 2

- Transistor output with open collector
- Signal whenever the needle is in the slot between position 2 and 2A
- Independent of sewing, thus also when turning the handwheel manually
- Suitable e. g. for the connection of a counter
- An inverted signal is issued at socket ST2/21

9.42 Signal Output 512 Impulses per Rotation

- Transistor output with open collector
- Signal whenever a generator slot of the position transmitter is sensed
- 512 impulses per rotation of the handwheel
- Independent of sewing, thus also when turning the handwheel manually
- Suitable e. g. for the connection of a counter
- An inverted signal is issued at socket ST2/22

9.43 Actuator

The commands for the sewing operation are input by means of the actuator, which is connected to the pedal. Instead of the built-on actuator another actuator can also be connected to socket B80.

Table: Coding of the Pedal Steps

Pedal step	D	C	B	A		
-2	H	H	L	L	Full heelback	(e. g. initiating the seam end)
-1	H	H	H	L	Slight heelback	(e. g. sewing foot lifting)
0	H	H	H	H	Pedal in pos. 0 (neutral)	
½	H	H	L	H	Pedal slightly forward	(e. g. sewing foot lowering)
1	H	L	L	H	Speed stage 1	(n1)
2	H	L	L	L	Speed stage 2	
3	H	L	H	L	Speed stage 3	
4	H	L	H	H	Speed stage 4	
5	L	L	H	H	Speed stage 5	
6	L	L	H	L	Speed stage 6	
7	L	L	L	L	Speed stage 7	
8	L	L	L	H	Speed stage 8	
9	L	H	L	H	Speed stage 9	
10	L	H	L	L	Speed stage 10	
11	L	H	H	L	Speed stage 11	
12	L	H	H	H	Speed stage 12	(n2) Pedal fully forward

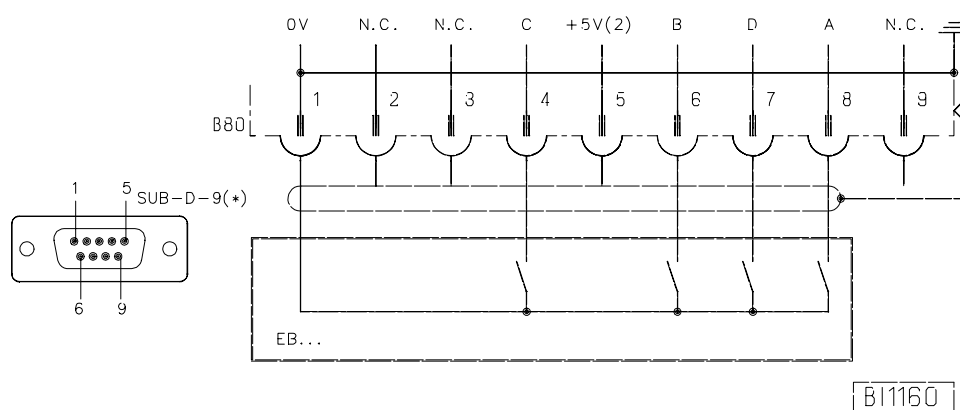

EB.. Actuator

Function with or without control panel	Parameter
Selectable pedal functions	(-Pd) 019

Parameter 019 = 0 Pedal in pos. -1 blocked in the seam. But with pedal in pos. -2 sewing foot lifting is possible in the seam (function active whenever the light barrier is On).

Parameter 019 = 1 With pedal in pos. -1 sewing foot lifting is blocked in the seam.

Parameter 019 = 2 With pedal in pos. -2 thread trimming is blocked (function active whenever the light barrier is On).

Parameter 019 = 3 The functions “pedal in pos. -1” and “pedal in pos. -2” are active.

Parameter 019 = 4 The functions “pedal in pos. -1” and “pedal in pos. -2” are blocked in the seam (function active whenever the light barrier is On).

Function with or without control panel	Parameter
Speed stage graduation (nSt)	119

The pedal characteristics (speed change from stage to stage) can be varied.

Possible characteristic curves:

- linear
- progressive
- highly progressive

9.44 Audible Signal

Function with control panel	Parameter
Audible signal On/Off (AkS)	127

An audible signal which sounds in the following cases can be enabled by means of parameter 127:

- When the bobbin thread monitor is On, after completion of the stitch count.
- When the machine run blockage is On.

10 Signal Test

Function with or without control panel	Parameter
Input and output test (Sr4)	173

Function test of external inputs and transistor power outputs with connected actuators (e.g. solenoids and solenoid valves).

10.1 Signal Test Using the Incorporated Control Panel or the V810/V820

Input Test:

- Select parameter 173.
- **Control:** Functions of signals “light barrier, sensor, generator impulse 1 and 2, positions 1 and 2” can be checked directly and indicated by means of LEDs 3...8. Inputs in1...in10 are displayed individually. Several switches and/or keys must not be actuated at the same time.
- **V810 control panel:** The above signals are indicated by means of arrows above the 2...4 keys. Inputs in1...in10 appear individually on the LC display. Several switches and/or keys must not be actuated at the same time (see control).
- **V820 control panel:** Inputs in1...in10 and signals “light barrier, sensor, generator impulse 1 and 2, positions 1 and 2” are displayed by means of arrows above the 1...10 keys. Several inputs can be actuated and displayed at the same time. If several keys and/or switches are actuated at the same time, e.g. **in3, in5, in6, in7**, the least significant input will be displayed, e.g. **in3**.

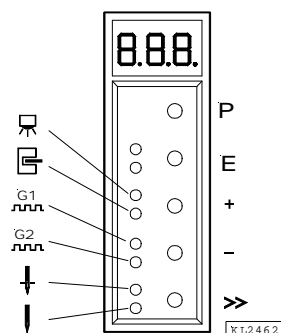

V820 Control Panel

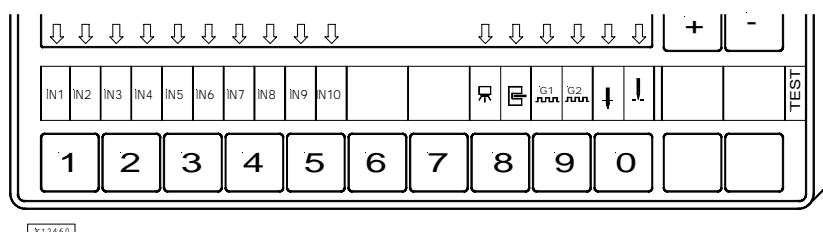

V810 Control Panel

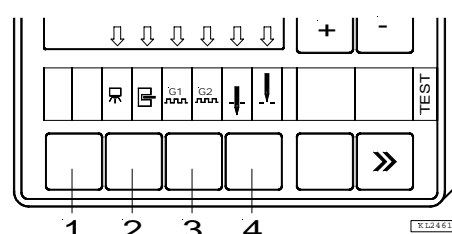

Note

If an input is active with open contact, the corresponding arrow lights up when the contact is open. If an input is active with closed contact, the corresponding arrow lights up when the contact is closed.

Output Test:

- Select the desired output by means of the +/- keys
- Enable the selected output by means of the >> key on the V810 or the incorporated control panel
- Enable the selected output by means of the key at the bottom right on the V820

Display	Assignment of the outputs	
01	Backtacking	on socket ST2/34
02	Sewing foot lift	on socket ST2/35
03	Output M1	on socket ST2/37
04	Output M3	on socket ST2/27
05	Output M2	on socket ST2/28
06	Output M4	on socket ST2/36
07	Output M5	on socket ST2/32
08	Output M11	on socket ST2/31
09	Output M6	on socket ST2/30
010	Output M9	on socket ST2/25
011	Output M8	on socket ST2/24
012	Output M7	on socket ST2/23
013	Output M10	on socket ST2/29

11 Error Displays

General Information			
On the control	On the V810	On the V820	Signification
A1	InF A1	InF A1	Pedal not in neutral position when turning the machine on
A2	-StoP- blinking	-StoP- blinking + symbol display	Machine run blockage
A3	InF A3	InF A3	Reference position is not set
A7	Symbol blinking	Symbol blinking	Bobbin thread monitor

Programming Functions and Values (Parameters)			
On the control	On the V810	On the V820	Signification
Returns to 000 or to last parameter number	Returns to 0000 or to last parameter number	Like V810 + display InF F1	Wrong code or parameter number input

Serious Condition			
On the control	On the V810	On the V820	Signification
E1	InF E1	InF E1	After power On, position transmitter or commutation transmitter defective, or connecting cables have been changed by mistake. During operation or after a sewing cycle, only position transmitter defects can be identified.
E2	InF E2	InF E2	Line voltage too low, or time between power Off and power On too short.
E3	InF E3	InF E3	Machine blocked or does not reach the desired speed.
E4	InF E4	InF E4	Control disturbed by deficient grounding or loose contact.
E9	InF E9	InF E9	Defective EEPROM.

Hardware Disturbance			
On the control	On the V810	On the V820	Signification
H1	InF H1	InF H1	Commutation transmitter cord or frequency converter disturbed.
H2	InF H2	InF H2	Processor disturbed

12 Operating Elements of the V810 Control Panel

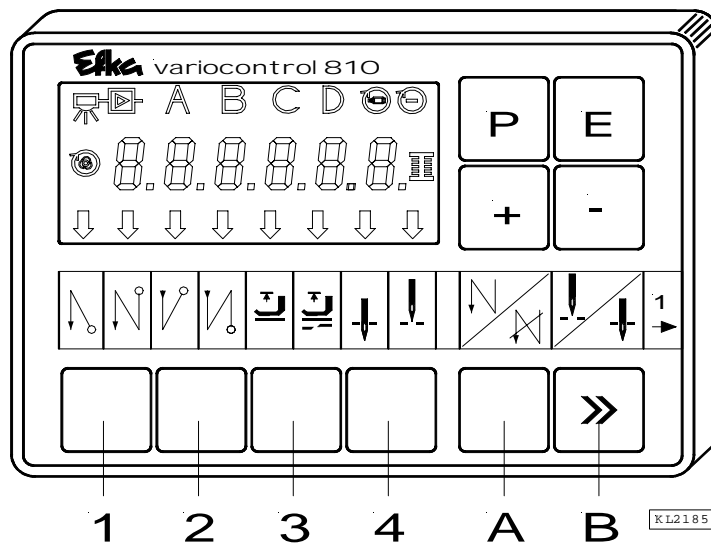

The V810 control panel is supplied with the **no. 1** slide-in strip above the keys. For different functions the strip can be replaced with another one supplied with the control panel. Set parameter **291** in this case. See also **V810 / V820** instruction manual!

Function Assignment to the Keys

P key = Call or exit of programming mode

E key = Enter key for modifications in the programming mode

+ key = Increase of the value indicated in the programming mode

- key = Decrease of the value indicated in the programming mode

1 key = Start backtack SINGLE / DOUBLE / OFF

2 key = End backtack SINGLE / DOUBLE / OFF

3 key = Automatic sewing foot lift after thread trimming ON / OFF
Automatic sewing foot lift at stop in the seam ON / OFF

4 key = Basic position needle down (POSITION 1) / needle up (POSITION 2)

A key = Key for intermediate backtack

(Different input functions can be assigned to the A key using parameter 293)

B key = Key for needle up/down or shift key in the programming mode

(Different input functions can be assigned to the B key using parameter 294)

13 Operating Elements of the V820 Control Panel

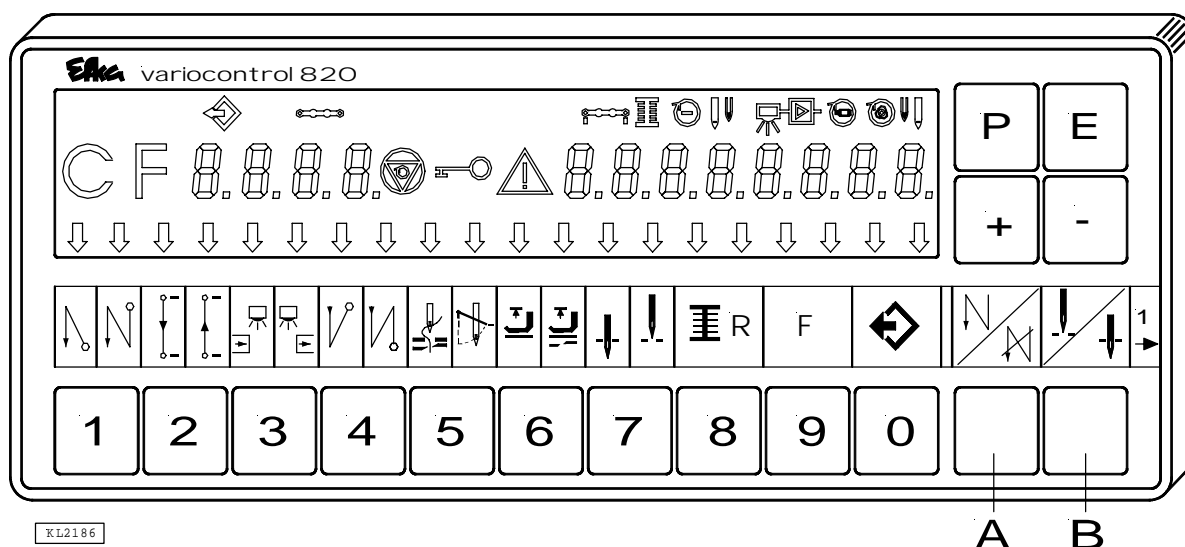

The V820 control panel is supplied with the **no. 1** slide-in strip above the keys. For different functions the strip can be replaced with another one supplied with the control panel. Set parameter **292** in this case. See also **V810 / V820** instruction manual!

Function Assignment to the Keys

- P key = Call or exit of programming mode
 - E key = Enter key for modifications in the programming mode
 - + key = Increase of the value indicated in the programming mode
 - key = Decrease of the value indicated in the programming mode
 - 1 key = Start backtack SINGLE / DOUBLE / OFF
 - 2 key = Stitch counting seam FORWARD / BACKWARD / OFF
 - 3 key = Light barrier function COVERED-UNCOVERED / UNCOVERED-COVERED / OFF
 - 4 key = End backtack SINGLE / DOUBLE / OFF
 - 5 key = THREAD TRIMMER / THREAD TRIMMER + THREAD WIPER / OFF
 - 6 key = Automatic sewing foot lift after thread trimming ON / OFF
Automatic sewing foot lift at stop in the seam ON / OFF
 - 7 key = Basic position needle down (POSITION 1) / needle up (POSITION 2)
 - 8 key = Bobbin thread monitor ON / OFF
 - 9 key = Function key - programmable
 - 0 key = Teach-in / execution of 40 possible seam sections
-
- A key = Key for backtack suppression/recall
(Different input functions can be assigned to the A key using parameter 293)
 - B key = Key for needle up/down or shift key in the programming mode
(Different input functions can be assigned to the B key using parameter 294)

Special Key Assignment for HIT

After having pressed the 1, 2, 3, 4 or 9 key, the following can be varied by means of the +/- keys:

- 1 key = Number of stitches of the selected start backtack
- 2 key = Number of stitches of the seam with stitch counting
- 3 key = Number of light barrier compensating stitches
- 4 key = Number of stitches of the selected end backtack
- 9 key = Number of stitches or On/Off of the programmed function



FRANKL & KIRCHNER GMBH & CO KG
SCHEFFELSTRASSE 73 – D-68723 SCHWETZINGEN
TEL.: (06202)2020 – TELEFAX: (06202)202115
email: info@efka.net – <http://www.efka.net>



OF AMERICA INC.
3715 NORTHCREST ROAD – SUITE 10 – ATLANTA – GEORGIA 30340
PHONE: (770)457-7006 – TELEFAX: (770)458-3899 – email: efkaus@efka.net



ELECTRONIC MOTORS SINGAPORE PTE. LTD.
67, AYER RAJAH CRESCENT 05-03 – SINGAPORE 139950
PHONE: 7772459 – TELEFAX: 7771048 – email: efkaems@efka.net